

# PROLUMIA®

PRODISC II MINI + PRODISC II  
+ PRODISC II MAXI



## OPERATING INSTRUCTION

GEBRUIKSAANWIJZING  
MANUEL D'UTILISATION  
INSTALAČNÍ NÁVOD  
GEBRAUCHSANLEITUNG

40009441	Prodisc II Mini
40009451	Prodisc II Mini + Microwave sensor
40009401	Prodisc II
40009411	Prodisc II + Microwave sensor
40009461	Prodisc II Maxi
40009471	Prodisc II Maxi + Microwave sensor

CE □ IP44   LED

## ATTENTIE

Lees de volgende instructies zorgvuldig door om ervoor te zorgen dat de montagewerkzaamheden op de juiste manier worden uitgevoerd. Bewaar deze instructies goed voor eventueel toekomstig gebruik.

## OPGELET

1. Het product dient te worden geïnstalleerd door gekwalificeerde personen. De installatie dient, voorafgaand aan de montage, spanningsloos te worden gemaakt.
2. De installatiedraad moet minimaal 2x 1,0 mm<sup>2</sup> zijn en worden aangesloten in overeenstemming met de laatste elektriciteitsvoorschriften van IEE of volgens de nationale eisen.
3. Raak het elektronische circuit en de componenten niet aan.
4. Raak de LED's niet aan tijdens installatie of onderhoud.
5. Dit product bevat een lichtbron van energie-efficiëntieklasse D.

## TECHNISCHE DATA

Voedingsspanning: AC 220-240V 50/60Hz

Lichtbron: LED SMD2835

Bedrijfstemperatuur:

-20°C – +50°C (Standaard) /

-20°C – +40°C (MW sensor)

Kleurtemperatuur schakelbaar:

3000K / 4000K

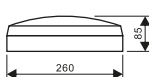

Prodisc II Mini

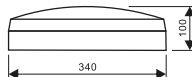

Prodisc II

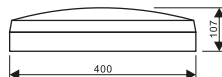

Prodisc II Maxi

## TECHNISCHE INFORMATIE

Artikelnr.	Spanning	LED type	Vermogen	Max. lichtstroom	MW sensor
40009441	220-240V 50/60Hz	SMD2835	9W	900Lm	-
40009451	220-240V 50/60Hz	SMD2835	10W	900Lm	Ja
40009401	220-240V 50/60Hz	SMD2835	14W	1500Lm	-
40009411	220-240V 50/60Hz	SMD2835	15W	1500Lm	Ja
40009461	220-240V 50/60Hz	SMD2835	24W	3000Lm	-
40009471	220-240V 50/60Hz	SMD2835	25W	3000Lm	Ja

## MICROWAVE SENSOR - BESCHRIJVING

Detectie-gevoeligheid: 25% - 100%, instelbaar

Daglicht 1: 5 - 15Lux, instelbaar of uitschakelen

Daglicht 2: 35 - 150Lux, instelbaar of uitschakelen (bij daglichtprioriteit)

Nalooptijd: 5 - 30sec - 1 - 5 - 15 - 30min (instelbaar)

Nalooptijd oriëntatieverlichting:

0 - 10 - 20 - 30 - 60 - ∞ min (instelbaar)

Montagehoogte: 6m max.

Bewegingsdetectie: 0,3 ~ 3m/s

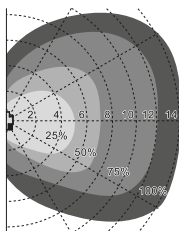

Detectiebereik wandmontage (Eenheid: m)  
Voorgestelde montagehoogte: 2m

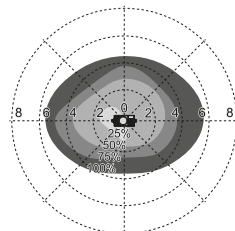

Detectiebereik plafondmontage (Eenheid: m)  
Voorgestelde montagehoogte: 3m

## MICROWAVE SENSOR - INSTELLING PARAMETERS

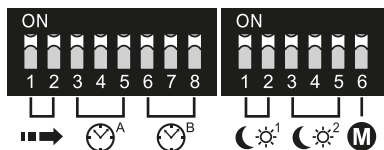

### ➡ Detectiebereik

Dit bepaalt het effectieve bereik van de bewegingsmelder en wordt met de micro-schakelaars op de sensor ingesteld, zie figuur onder. Wees er van bewust dat het verminderen van de gevoeligheid ook het detectiebereik zal verkleinen.

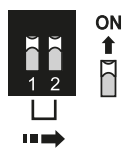

	1	2	
I	ON	ON	100%
II	—	ON	75%
III	ON	—	50%
IV	—	—	25%

### ⌚<sup>B</sup> Nalooptijd oriëntatieverlichting

Gedurende deze periode zal het armatuur op laag niveau (20%) branden. Wanneer deze is ingesteld op +∞ geeft het armatuur permanent 20% licht als er geen beweging gedetecteerd wordt. Dit wordt ingesteld met micro-schakelaars op de sensor, zie figuur onder.

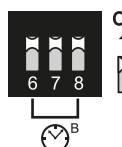

	6	7	8	
I	ON	ON	ON	0s
II	—	ON	ON	10min
III	ON	—	ON	20min
IV	—	—	ON	30min
V	ON	ON	—	60min
VI	—	—	—	+∞

### ☀<sup>2</sup> Daglicht 2

Dit is alleen van toepassing onder modus 2. Het verwijst naar het daglichtniveau waaronder het armatuur op laag niveau gaat branden.

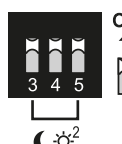

	3	4	5	
I	ON	ON	ON	Disable
II	—	ON	ON	150Lux
III	ON	—	ON	100Lux
IV	—	—	ON	75Lux
V	ON	—	—	50Lux
VI	—	—	—	35Lux

### ⌚<sup>A</sup> Nalooptijd

Dit bepaalt de tijd dat het armatuur op 100% niveau blijft branden. Dit kan worden ingesteld met micro-schakelaars op de sensor, zie figuur onder. Tijdens het installeren van het armatuur is de looptest-instelling (5s) handig om de juiste werking en het bereik vast te stellen.



	3	4	5	
I	ON	ON	ON	5s
II	—	ON	ON	30s
III	ON	—	ON	1min
IV	—	—	ON	5min
V	ON	ON	—	15min
VI	—	—	—	30min

### ☀<sup>1</sup> Daglicht 1

Hiermee kan de sensor het armatuur inschakelen wanneer het omgevingslicht volledig daglicht (15Lux), weinig daglicht (10Lux) of donker (5Lux) is. Ook kan de sensor hiermee worden uitgeschakeld. Dit wordt ingesteld met micro-schakelaars op de sensor, zie figuur onder. Zolang het lichtniveau boven de ingestelde waarde ligt, zal het armatuur bij bewegingsdetectie uitbliven.

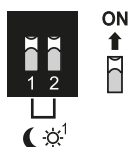

	1	2	
I	ON	ON	Disable
II	—	ON	15Lux
III	ON	—	10Lux
IV	—	—	5Lux

### M Mode

Modus 1: Armatuur blijft uit bij bewegingsdetectie indien het daglichtniveau boven de bij "Daglicht 1" ingestelde waarde ligt. Modus 2: Indien het daglichtniveau onder de bij "Daglicht 2" ingestelde waarde komt, zal het armatuur op laag niveau gaan branden. Bij bewegingsdetectie wordt opgeschakeld naar 100%.

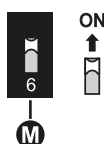

	6	
I	ON	Mode 1
II	—	Mode 2

NL

EN

FR

CZ

DE

# MICROWAVE SENSOR - INSTELLING PARAMETERS

## A 0% / 100% / 20%

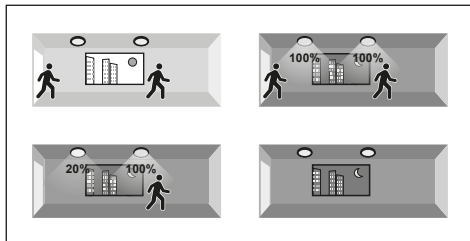

**M** Modus

ON	6		
I	ON	Mode 1	✓
II	—	Mode 2	

**N** Nalooptijd

ON	6	7	8	
I	ON	ON	ON	0s
II	—	ON	ON	10min
III	ON	—	ON	20min
IV	—	—	ON	30min
V	ON	ON	—	60min
VI	—	—	—	+∞

## B 0% / 100%

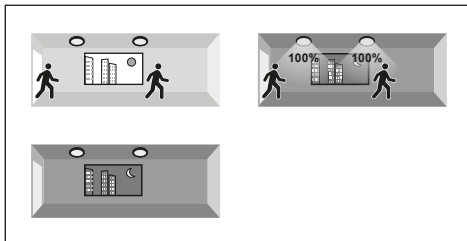

**M** Modus

ON	6		
I	ON	Mode 1	✓
II	—	Mode 2	

**N** Nalooptijd

ON	6	7	8	
I	ON	ON	ON	0s
II	—	ON	ON	10min
III	ON	—	ON	20min
IV	—	—	ON	30min
V	ON	ON	—	60min
VI	—	—	—	+∞

## C 20% / 100%

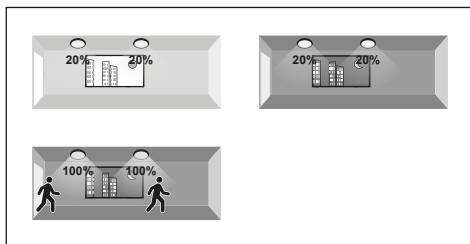

**M** Modus

ON	6		
I	ON	Mode 1	✓
II	—	Mode 2	

**N** Nalooptijd

ON	6	7	8	
I	ON	ON	ON	0s
II	—	ON	ON	10min
III	ON	—	ON	20min
IV	—	—	ON	30min
V	ON	ON	—	60min
VI	—	—	—	+∞

## D 0% / 20% op basis van daglicht / 100% bij beweging

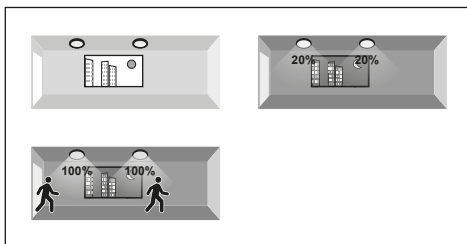

**M** Modus

ON	6		
I	ON	Mode 1	✓
II	—	Mode 2	



## MASTER/SLAVE FUNCTIE

### Functie A

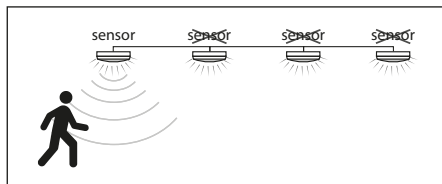

### Functie B

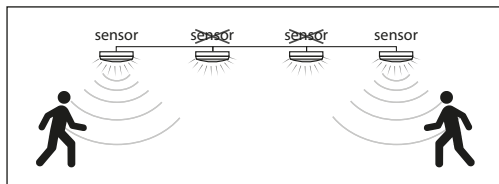

### Functie A - Centraal geschakeld

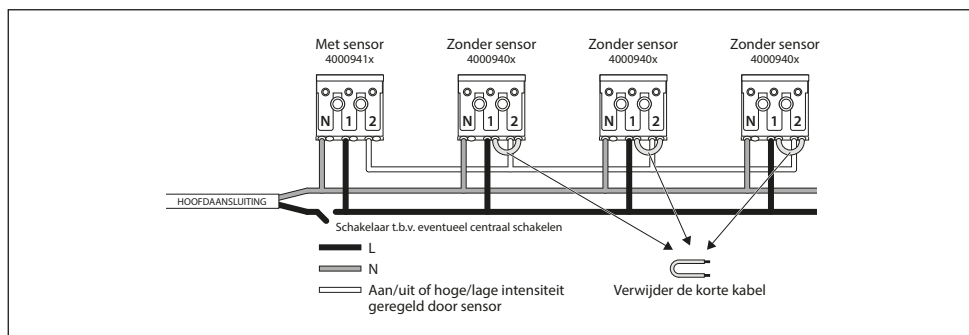

### Functie B - Alleen geschakeld d.m.v. ingebouwde sensoren

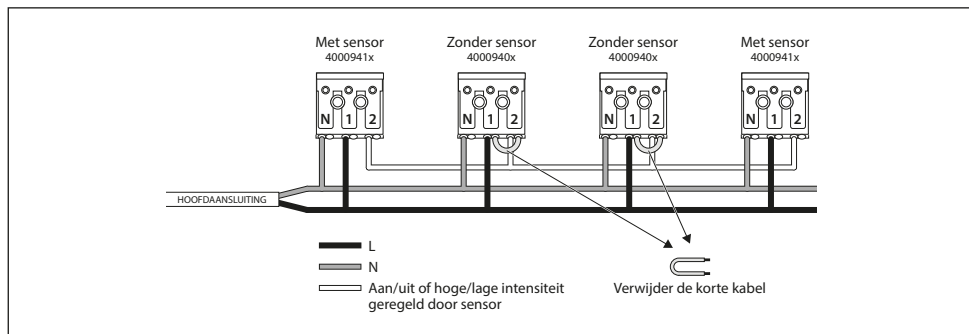

Het aantal units in slave-functie is gelimiteerd (max. 60 stuks).

NL

EN

FR

CZ

DE

## MONTAGE

1. Draai de afscherming los en open het LED paneel.
2. Haal het aansluitsnoer door de thule en fixeer met de trekcontlasting.
3. Bevestig het armatuur d.m.v. schroeven op de ondergrond.
4. Sluit het aansluitsnoer correct aan op de terminal.
5. Sluit het LED paneel en bevestig de afscherming.

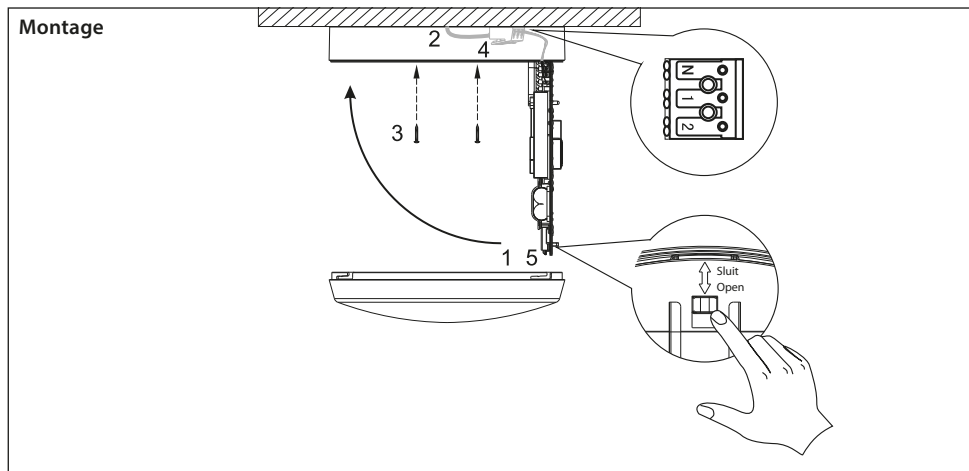

### 4 Aansluiting kabel

HOOFDAANSLUITING

Verwijder bij Master/Slave gebruik

Zonder sensor

HOOFDAANSLUITING

Met sensor

(geschakelde fase niet verplicht)

## KEUZE LICHTKLEUR

U kunt het armatuur instellen op 2 verschillende lichtkleuren.

De schakelaar is te vinden op de LED module en is te zien wanneer u de beschermingskap heeft verwijderd.

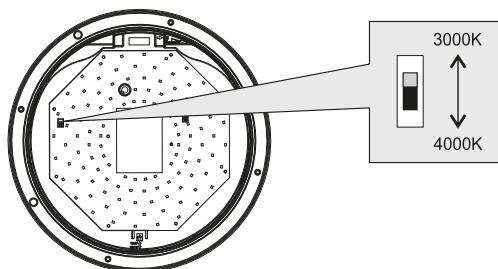

## KEUZE LICHTOPBRENGST

U kunt het armatuur instellen op 2 of 3 verschillende Lumen waarden.

De schakelaar is te vinden op de LED module en is te zien wanneer u de beschermingskap heeft verwijderd.

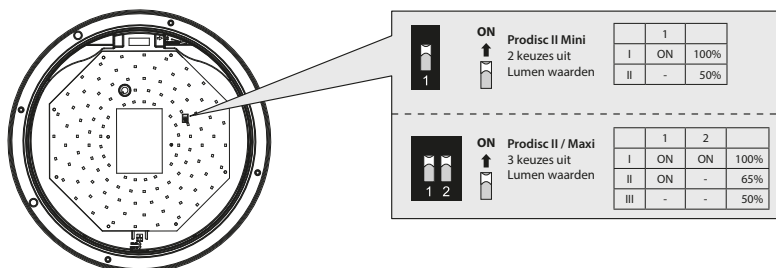

## ONDERHOUD

1. Maak het armatuur spanningsloos.
2. Raak de LED's niet aan tijdens onderhoud of schoonmaak.
3. Gebruik geen chemische schoonmaakmiddelen om de lamp te reinigen.

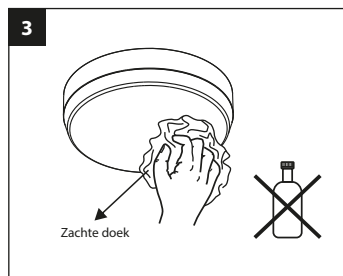
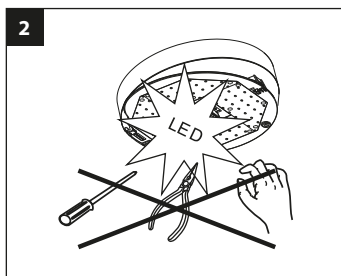
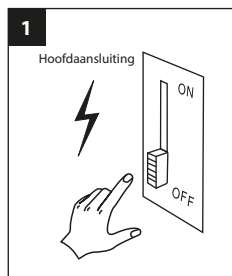

## BESCHERMING VAN HET MILIEU

Defecte elektrische apparaten behoren niet te worden weggegooid bij het huishoudelijk afval. Recycle waar mogelijk. Neem contact op met uw gemeente of uw leverancier voor een deskundig recycling advies.



## ATTENTION

Please read the following instructions carefully to ensure that mounting operation will be carried out correctly. These instructions should be properly preserved for future reference.

## CAUTION

1. The product must be installed by qualified technicians. The power supply must be cut before installation.
2. The installation wiring must be  $2 \times 1.0 \text{ mm}^2$  at least and wired in accordance with the latest IEE electrical regulations or the national requirements.
3. Do not touch the electronic circuit and its components.
4. Do not touch the LEDs while installing or maintaining.
5. This product contains a light source of energy efficiency class D.

## TECHNICAL DATA

Supply voltage: AC 220-240V 50/60Hz

Light source: LED SMD2835

Operating temperature:

-20°C – +50°C (Standard) /

-20°C – +40°C (MW sensor)

Color temperature switchable:

3000K / 4000K

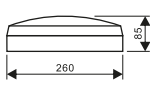

Prodisc II Mini

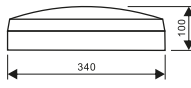

Prodisc II

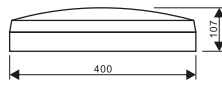

Prodisc II Maxi

## TECHNICAL INFORMATION

Article no.	Voltage	LED type	Power	Max. light output	MW sensor
40009441	220-240V 50/60Hz	SMD2835	9W	900Lm	-
40009451	220-240V 50/60Hz	SMD2835	10W	900Lm	Yes
40009401	220-240V 50/60Hz	SMD2835	14W	1500Lm	-
40009411	220-240V 50/60Hz	SMD2835	15W	1500Lm	Yes
40009461	220-240V 50/60Hz	SMD2835	24W	3000Lm	-
40009471	220-240V 50/60Hz	SMD2835	25W	3000Lm	Yes

## MICROWAVE SENSOR - DESCRIPTION

Detection sensitivity: 25% - 100%, adjustable

Daylight 1: 5 - 15Lux, adjustable or disable

Daylight 2: 35 - 150Lux, adjustable or disable  
(with daylight priority)

Hold time: 5 - 30sec - 1 - 5 - 15 - 30min (adjustable)

Hold time orientation lighting:

0 - 10 - 20 - 30 - 60 - ∞ min (adjustable)

Mounting height: 6m max.

Motion detection: 0.3 ~ 3m/s

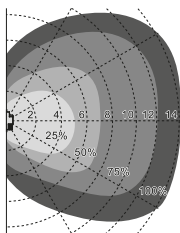

Wall mounting detection area (Unit: m)  
Suggested installation height: 2m

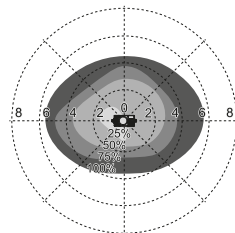

Ceiling mounting detection area (Unit: m)  
Suggested installation height: 3m

## MICROWAVE SENSOR - PARAMETER SETTINGS

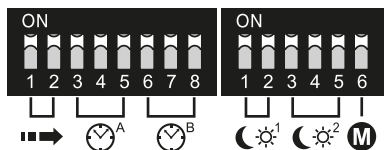

### ➡ Detection Area

This determines the effective range of the motion detector and is set with DIP switches on the sensor, please see figure below. Note that reducing the sensitivity will also narrow the detection range.

	1	2	
I	ON	ON	100%
II	—	ON	75%
III	ON	—	50%
IV	—	—	25%

### 🕒<sup>A</sup> Hold Time

This determines the time the fixture remains at 100% and is set with DIP switches on the sensor, please see figure below. The walk test (5s) setting is useful when installing the fixture to establish correct operation and range.

	3	4	5	
I	ON	ON	ON	5s
II	—	ON	ON	30s
III	ON	—	ON	1min
IV	—	—	ON	5min
V	ON	ON	—	15min
VI	—	—	—	30min

### 🕒<sup>B</sup> Hold time orientation lighting

During this period, the fixture will light up at low level (20%). When this is set to +∞, the fixture gives permanent 20% light when no movement detected. It is set with DIP switches on the sensor, please see figure below.

	6	7	8	
I	ON	ON	ON	0s
II	—	ON	ON	10min
III	ON	—	ON	20min
IV	—	—	ON	30min
V	ON	ON	—	60min
VI	—	—	—	+∞

### ☀️<sup>1</sup> Daylight 1

This allows the sensor to switch the unit on when daylight level is either full daylight (15Lux), low daylight (10Lux), or after dark (5Lux). It also allows the sensor to be disabled. As long as the light level is above the set point, the fixture will stay off when motion is detected.

	1	2	
I	ON	ON	Disable
II	—	ON	15Lux
III	ON	—	10Lux
IV	—	—	5Lux

### ☀️<sup>2</sup> Daylight 2

This is only applicable under mode 2. Under this daylight level the fixture will light at low level.

	3	4	5	
I	ON	ON	ON	Disable
II	—	ON	ON	150Lux
III	ON	—	ON	100Lux
IV	—	—	ON	75Lux
V	ON	—	—	50Lux
VI	—	—	—	35Lux

### Ⓜ Mode

Mode 1: Fixture remains off during motion if the daylight level is above the value set at "Daylight 1".

Mode 2: When the daylight level falls below the value set under "Daylight 2", the fixture will light at low level. When motion is detected, it is shifting to 100%.

	6	
I	ON	Mode 1
II	—	Mode 2

# MICROWAVE SENSOR - PARAMETER SETTINGS

## A 0% / 100% / 20%

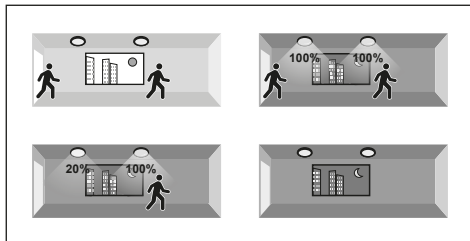

**M** Mode

ON	6		
I	ON	Mode 1	✓
II	—	Mode 2	

**M**

**Hold time**

ON	6	7	8	
I	ON	ON	ON	0s
II	—	ON	ON	10min
III	ON	—	ON	20min
IV	—	—	ON	30min
V	ON	ON	—	60min
VI	—	—	—	+∞

## B 0% / 100%

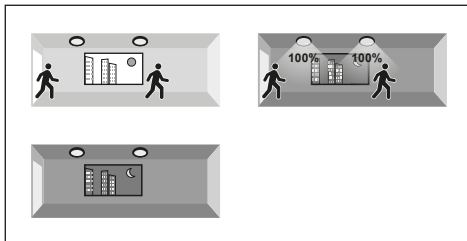

**M** Mode

ON	6		
I	ON	Mode 1	✓
II	—	Mode 2	

**M**

**Hold time**

ON	6	7	8	
I	ON	ON	ON	0s
II	—	ON	ON	10min
III	ON	—	ON	20min
IV	—	—	ON	30min
V	ON	ON	—	60min
VI	—	—	—	+∞

## C 20% / 100%

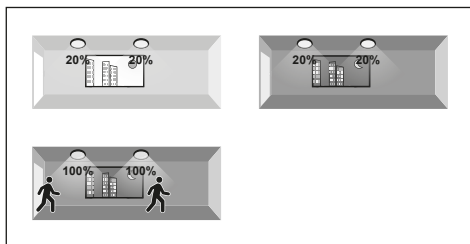

**M** Mode

ON	6		
I	ON	Mode 1	✓
II	—	Mode 2	

**M**

**Hold time**

ON	6	7	8	
I	ON	ON	ON	0s
II	—	ON	ON	10min
III	ON	—	ON	20min
IV	—	—	ON	30min
V	ON	ON	—	60min
VI	—	—	—	+∞

## D 0% / 20% based upon daylight / 100% when triggered

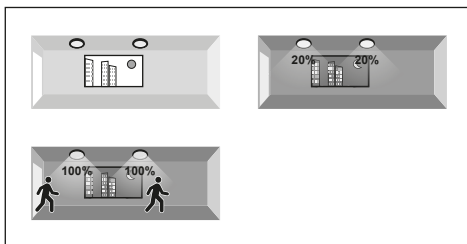

**M** Mode

ON	6		
I	ON	Mode 1	✓
II	—	Mode 2	

**M**

# MASTER/SLAVE FUNCTION

## Function A

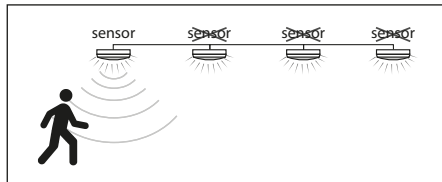

## Function B

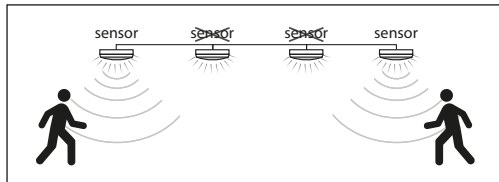

### Function A - Central switched

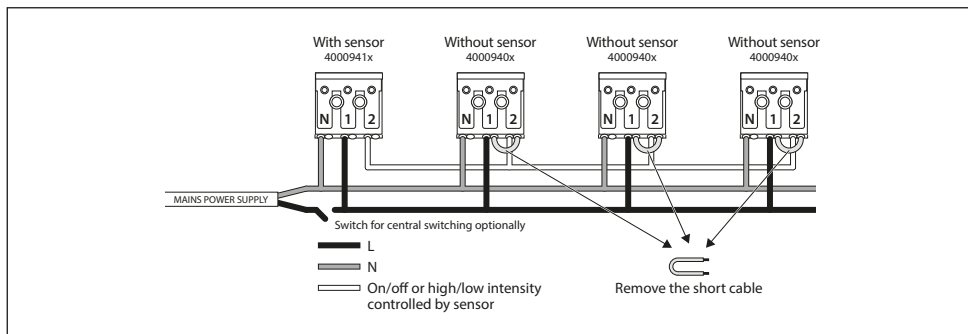

### Function B - Only switched by means of built-in sensors

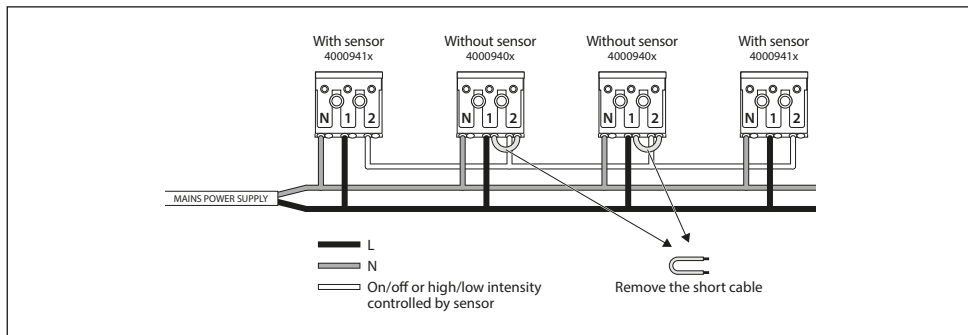

**⚠ The number of slaves is limited (max. 60 pcs).**

NL

EN

FR

CZ

DE

## MOUNTING

1. Disassemble the diffuser and LED panel.
2. Pull the power cord through the gasket.
3. Fix the fixture on the surface with screws.
4. Connect the power cord on the terminal correctly.
5. Assemble the LED panel and diffuser.

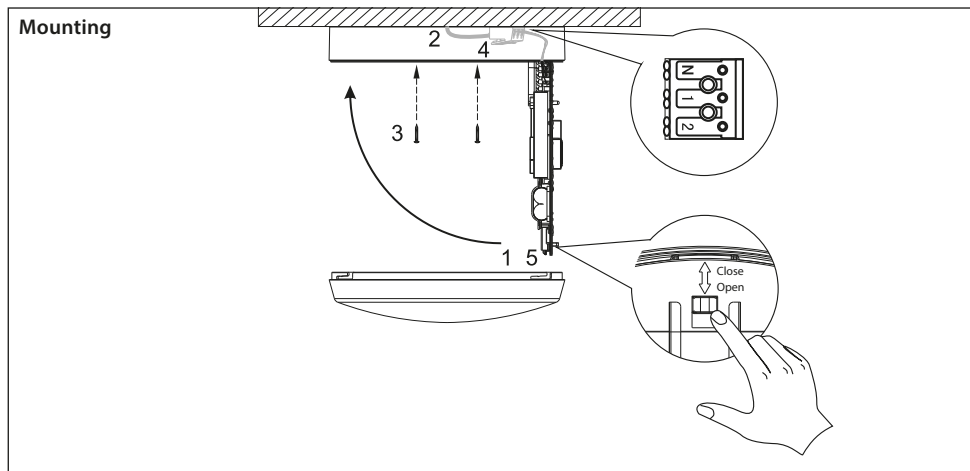

### 4 Cable connection

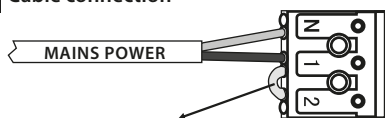

Without sensor

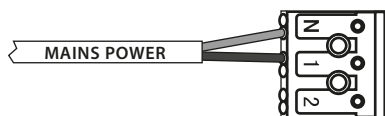

With sensor  
(switched phase not required)



## OPTIONAL COLOR TEMPERATURE

There are 2 choices of color temperature by different setting on the surface of the LED light engine. The switch can be found on the LED module and can be seen when you have removed the protective cap.

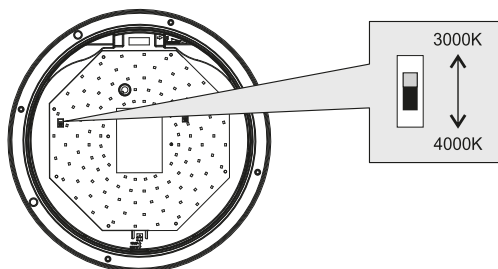

## OPTIONAL OUTPUT BRIGHTNESS

There are 2 or 3 choices of output brightness by different setting on the surface of the LED light engine. The switch can be found on the LED module and can be seen when you have removed the protective cap.

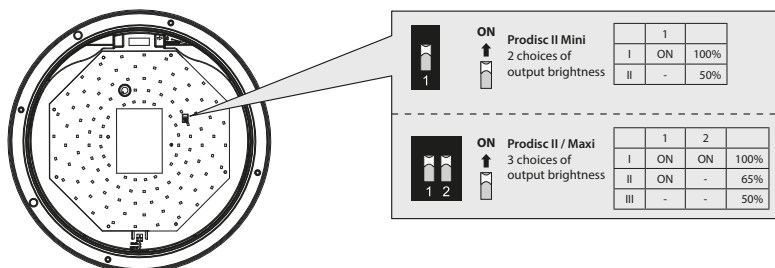

## MAINTENANCE

1. Cut off the mains power first.
2. Don't touch the LEDs while maintaining or cleaning.
3. Don't use chemical reagent to clean lamp.

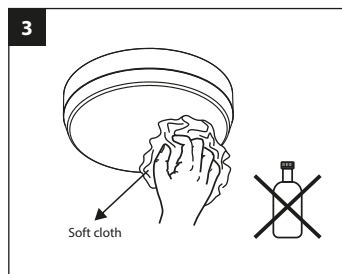
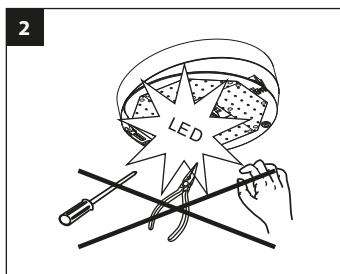
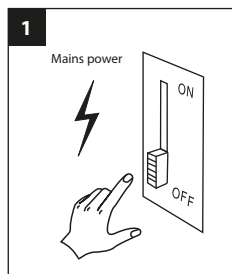

## ENVIRONMENTAL PROTECTION

Waste electrical products should not be disposed of with household waste. Please recycle where facilities exist. Check with your local authority or retailer for recycling advice.



## ATTENTION

Lisez attentivement les instructions suivantes pour vous assurer que les travaux d'installation sont effectués correctement. Conservez ces instructions en toute sécurité pour une utilisation future possible.

## ATTENTION

1. Le produit doit être installé par des personnes qualifiées. L'installation doit être mise hors tension avant l'installation.
2. Le câble d'installation doit avoir au moins 2x 1,0 mm<sup>2</sup> et doit être raccordé conformément aux dernières réglementations électriques de l'IEE ou selon les exigences nationales.
3. Ne touchez pas le circuit électronique et les composants.
4. Ne touchez pas les voyants pendant l'installation ou la maintenance.
5. Ce produit contient une source lumineuse de classe d'efficacité énergétique D.

## DONNÉES TECHNIQUES

Tension d'alimentation: AC 220-240V 50/60Hz

Source de lumière: LED SMD2835

Température de fonctionnement:

-20°C – +50°C (Standard) /

-20°C – +40°C (Capteur micro-ondes)

Température de couleur réglable:

3000K / 4000K

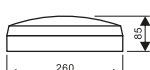

Prodisc II Mini

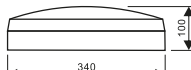

Prodisc II

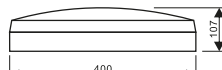

Prodisc II Maxi

## INFORMATIONS TECHNIQUES

Numéro article	Tension d'alimentation	Type LED	Puissance*	Flux lumineux maximal	Capteur
40009441	220-240V 50/60Hz	SMD2835	9W	900Lm	-
40009451	220-240V 50/60Hz	SMD2835	10W	900Lm	Oui
40009401	220-240V 50/60Hz	SMD2835	14W	1500Lm	-
40009411	220-240V 50/60Hz	SMD2835	15W	1500Lm	Oui
40009461	220-240V 50/60Hz	SMD2835	24W	3000Lm	-
40009471	220-240V 50/60Hz	SMD2835	25W	3000Lm	Oui

## CAPTEUR DE MICRO-ONDES - DESCRIPTION

Sensibilité de détection: 25% - 100%, réglable

Lumière du jour 1: 5 - 15Lux, réglable ou désactiver

Lumière du jour 2: 35 - 150Lux, réglable ou désactiver (en priorité jour)

Temps de suivi: 5 - 30sec - 1 - 5 - 15 - 30min (réglable)

Temps de suivi lumière d'orientation: 0 - 10 - 20 - 30 - 60 - ∞ min (réglable)

Hauteur d'installation: 6m max.

Détection de mouvement: 0,3 ~ 3m/s

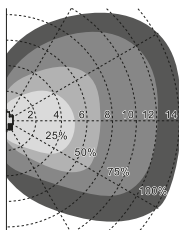

Portée de détection montage mural (Unité: m)  
Hauteur de montage proposée: 2m

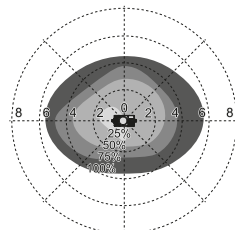

Portée de détection montage au plafond (Unité: m)  
Hauteur de montage proposée: 3m

## CAPTEUR DE MICRO-ONDES - RÉGLAGE DES PARAMÈTRES

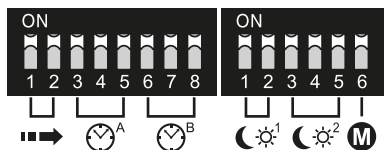

### Portée de détection

Ceci détermine la portée effective du détecteur de mouvement et sera réglé par les micro-interrupteurs sur le capteur, voir la figure ci-dessous. Sachez que réduire la sensibilité réduira également la plage de détection.

	1	2	
I	ON	ON	100%
II	—	ON	75%
III	ON	—	50%
IV	—	—	25%

### Temps de suivi éclairage d'orientation

Pendant cette période, le luminaire brûlera au niveau bas (20%). Lorsque ce paramètre est réglé sur +∞, le luminaire s'allume en permanence 20% si aucun mouvement n'est détecté. Ceci est réglé par des micro-interrupteurs sur le capteur, voir la figure ci-dessous.

	6	7	8	
I	ON	ON	ON	0s
II	—	ON	ON	10min
III	ON	—	ON	20min
IV	—	—	ON	30min
V	ON	ON	—	60min
VI	—	—	—	+∞

### Lumière de jour 2

Ceci n'est applicable que dans le mode 2.

Il se réfère au niveau de la lumière du jour auquel le luminaire au niveau bas s'allume.

	3	4	5	
I	ON	ON	ON	Disable
II	—	ON	ON	150Lux
III	ON	—	ON	100Lux
IV	—	—	ON	75Lux
V	ON	—	—	50Lux
VI	—	—	—	35Lux

### Temps de suivi

Ceci détermine le temps pendant lequel le luminaire reste allumé à 100%. Ceci peut être réglé avec les micro-interrupteurs sur le capteur, voir la figure ci-dessous. Lors de l'installation du luminaire, le réglage du test de marche (5s) est utile afin de déterminer le fonctionnement et la portée correcte.

	3	4	5	
I	ON	ON	ON	5s
II	—	ON	ON	30s
III	ON	—	ON	1min
IV	—	—	ON	5min
V	ON	ON	—	15min
VI	—	—	—	30min

### Lumière de jour 1

Ceci permet au capteur d'allumer le luminaire lorsque la lumière ambiante est en plein jour (15Lux), en basse lumière (10Lux) ou sombre (5Lux). Il permet également de désactiver le capteur. Ceci est réglé par des micro-interrupteurs sur le capteur, voir la figure ci-dessous. Tant que le niveau d'éclairage est supérieur à la valeur définie, le luminaire restera éteint pendant la détection de mouvement.

	1	2	
I	ON	ON	Disable
II	—	ON	15Lux
III	ON	—	10Lux
IV	—	—	5Lux

### Mode

Mode 1: Le luminaire restera éteint pendant la détection de mouvement si le niveau de lumière du jour est supérieur à la valeur réglée sur "Lumière de jour 1".  
Mode 2: Si le niveau de la lumière de jour tombe en dessous de la valeur réglée sur "Lumière de jour 2", le luminaire s'allume au niveau bas. En cas de détection de mouvement, il passera à 100%.

	6	
I	ON	Mode 1
II	—	Mode 2

# CAPTEUR DE MICRO-ONDES - RÉGLAGE DES PARAMÈTRES

## A 0% / 100% / 20%

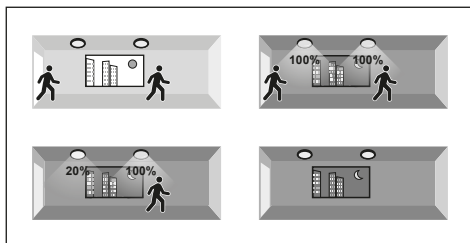

**M** Mode

ON	6		
I	ON	Mode 1	✓
II	—	Mode 2	

**M**

**⌚** Temps de suivi

ON	6	7	8	
I	ON	ON	ON	0s
II	—	ON	ON	10min
III	ON	—	ON	20min
IV	—	—	ON	30min
V	ON	ON	—	60min
VI	—	—	—	+∞

## B 0% / 100%

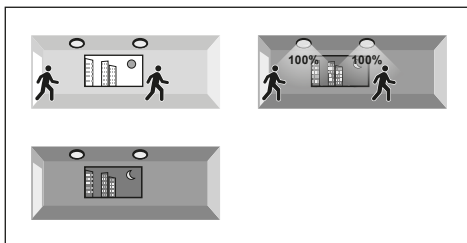

**M** Mode

ON	6		
I	ON	Mode 1	✓
II	—	Mode 2	

**M**

**⌚** Temps de suivi

ON	6	7	8	
I	ON	ON	ON	0s
II	—	ON	ON	10min
III	ON	—	ON	20min
IV	—	—	ON	30min
V	ON	ON	—	60min
VI	—	—	—	+∞

## C 20% / 100%

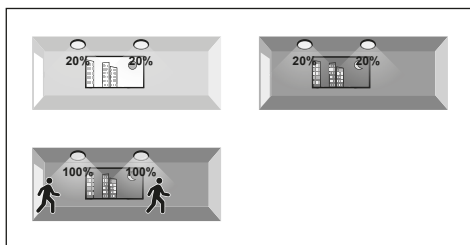

**M** Mode

ON	6		
I	ON	Mode 1	✓
II	—	Mode 2	

**M**

**⌚** Temps de suivi

ON	6	7	8	
I	ON	ON	ON	0s
II	—	ON	ON	10min
III	ON	—	ON	20min
IV	—	—	ON	30min
V	ON	ON	—	60min
VI	—	—	—	+∞

## D 0% / 20% basé sur la lumière du jour / 100% en cas de mouvement

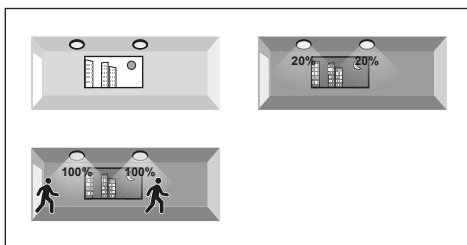

**M** Mode

ON	6		
I	ON	Mode 1	✓
II	—	Mode 2	

**M**

## FONCTION MAÎTRE / ESCLAVE

### Fonction A

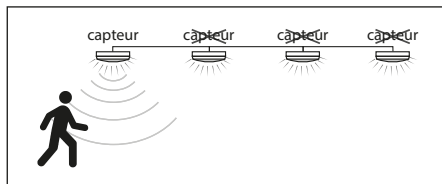

### Fonction B

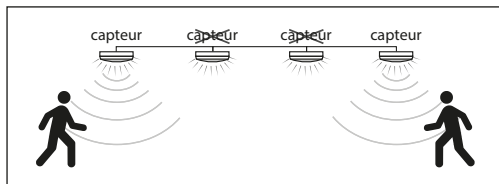

#### Fonction A - Commutation centralisée

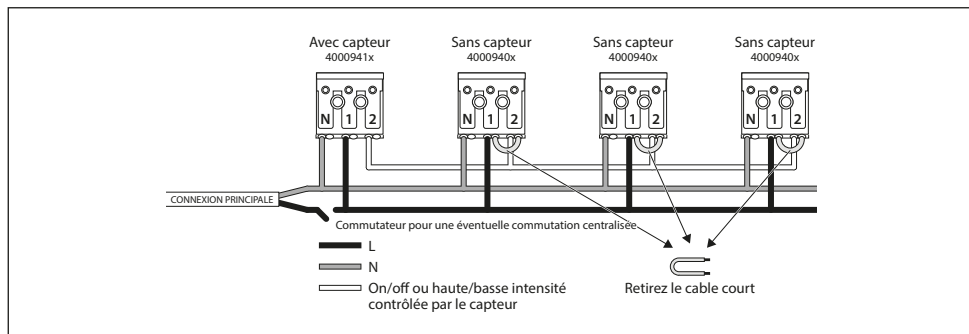

#### Fonction B - Seulement commuté au moyen de capteurs intégrés

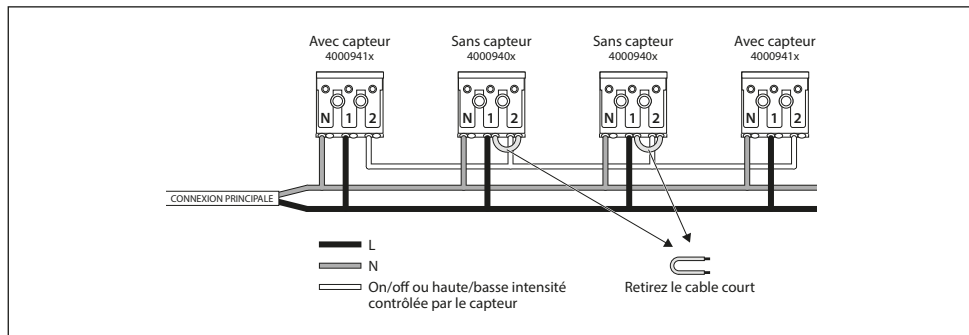

 Le nombre d'unités dans la fonction esclave est limité (max. 60 pièces).

NL

EN

FR

CZ

DE

## INSTALLATION

1. Dévissez le blindage et ouvrez le panneau LED.
2. Passer le câble à travers le thule et le fixer avec le réducteur de tension.
3. Fixez l'appareil au moyen de vis sur la surface.
4. Connectez le câble de connexion au terminal correctement.
5. Fermez le panneau LED et fixez le blindage

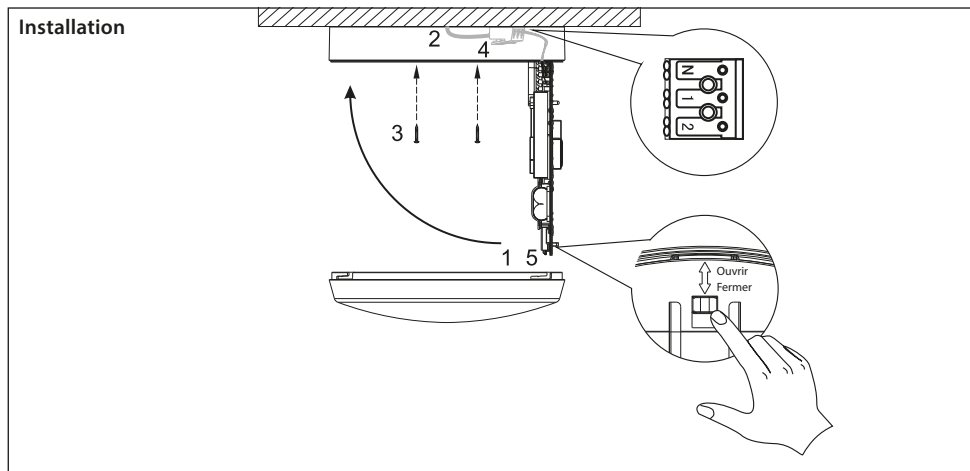

### 4 Câble de connexion

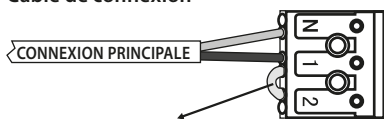

Supprimer en cas d'utilisation maître / esclave  
Sans capteur

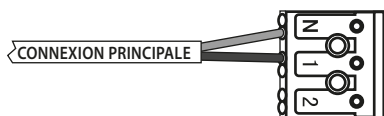

Avec capteur  
(phase commutée non requise)

## CHOIX DE LA TEMPÉRATURE DE COULEUR

Vous pouvez régler le luminaire sur 2 températures de couleur différentes.

L'interrupteur se trouve à côté du module LED et peut être vu lorsque vous avez retiré le capuchon de protection.

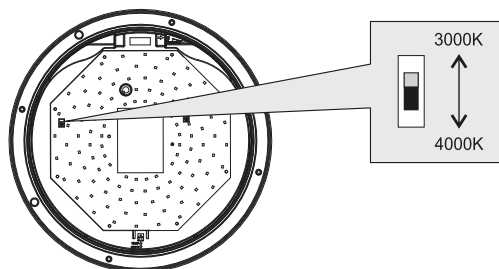

## CHOIX DE LA SORTIE DE LUMIÈRE

Vous pouvez définir l'appareil à 2 ou 3 valeurs Lumen différentes.

L'interrupteur se trouve à côté du module LED et peut être vu lorsque vous avez retiré le capuchon de protection.

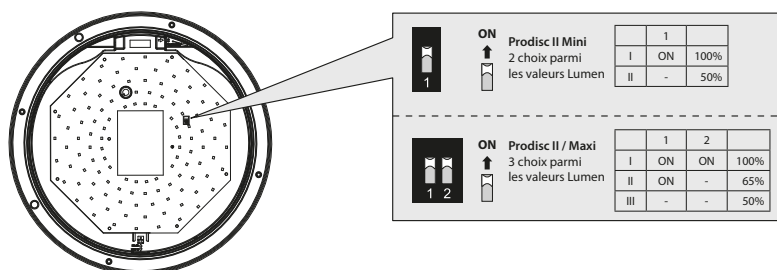

## ENTRETIEN

1. Couper la tension du luminaire.
2. Ne touchez pas les LED pendant l'entretien ou le nettoyage.
3. N'utilisez pas de produits de nettoyage chimiques pour nettoyer le luminaire.

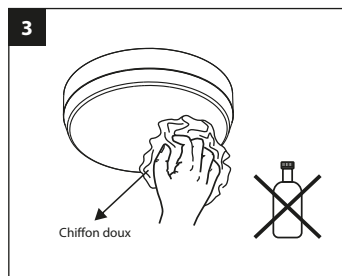
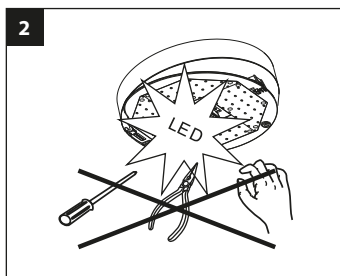
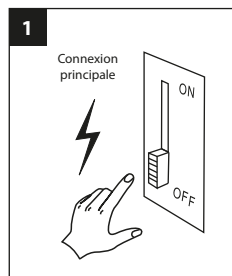

## PROTECTION DE L'ENVIRONNEMENT

Les appareils électriques défectueux ne doivent pas être jetés avec les ordures ménagères. Recycler si possible. Contactez votre municipalité ou votre fournisseur pour obtenir des conseils spécialisés en matière de recyclage.



## UPOZORNĚNÍ

Prosíme, přečtěte si pozorně návod k použití před začátkem instalace. Tento návod k použití si uchovejte pro případnou budoucí potřebu.

## UPOZORNĚNÍ

1. Instalace může být provedena pouze kvalifikovaným pracovníkem. Přívod proudu musí být odpojen před začátkem instalace.
2. Průřez vodičů připojovacího vedení musí být min. 2x 1,0 mm<sup>2</sup> a zapojení dle IEE mezinárodních elektrických regulací.
3. Nedotýkejte se elektrického obvodu a jeho komponentů.
4. Nedotýkejte se LED diod během instalace ani při údržbě.
5. Tento výrobek obsahuje světelný zdroj s třídou energetické účinnosti D.

## TECHNICKÁ DATA

Napájení: AC 220-240V 50/60Hz

Světelný zdroj: LED SMD2835

Provozní teplota: -20°C – +50°C (Standard) /  
-20°C – +40°C (MW čidlo)

Teplota chormatickosti přepínatelná:

3000K / 4000K

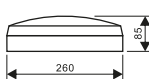

Prodisc II Mini

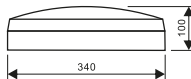

Prodisc II

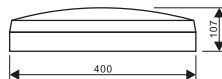

Prodisc II Maxi

## TECHNICKÉ INFORMACE

Obj.č.	Napájení	Typ LED	Příkon	Maximální světelný tok	Senzor
40009441	220-240V 50/60Hz	SMD2835	9W	900Lm	-
40009451	220-240V 50/60Hz	SMD2835	10W	900Lm	Ano
40009401	220-240V 50/60Hz	SMD2835	14W	1500Lm	-
40009411	220-240V 50/60Hz	SMD2835	15W	1500Lm	Ano
40009461	220-240V 50/60Hz	SMD2835	24W	3000Lm	-
40009471	220-240V 50/60Hz	SMD2835	25W	3000Lm	Ano

## MIKROVLNNÝ SENZOR - POPIS

Citlivost detekce: 25% - 100%, lze přizpůsobit

Režim denního osvětlení 1:

5 - 15Lux, lze přizpůsobit nebo vypnout

Režim denního osvětlení 2:

35 - 150Lux, lze přizpůsobit nebo vypnout  
(s prioritou denního osvětlení)

Doba plného osvětlení:

5 - 30 s - 1 - 5 - 15 - 30 min, lze přizpůsobit

Doba orientačního osvětlení:

0 - 10 - 20 - 30 - 60 - ∞ min, lze přizpůsobit

Montážní výška: 6m max.

Detektor pohybu: 0,3 ~ 3m/s

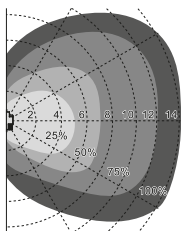

Oblast detekce při nástěnné montáži (Jednotka: m)  
Doporučená montážní výška: 2m

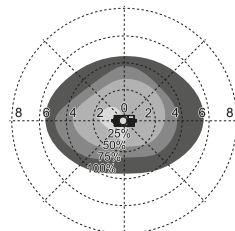

Oblast detekce při stropní montáži (Jednotka: m)  
Doporučená montážní výška: 3m



## NASTAVENÍ PARAMETRŮ MV SENZORU

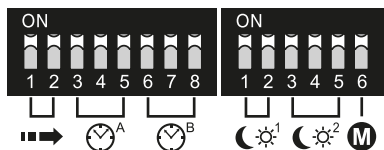

### ➡ Oblast detekce

Tato funkce definuje rozsah detektoru pohybu a je nastavitelná pomocí přepínačů na senzoru, viz náčrty níže. Redukce citlivosti také zúží oblast detekce.

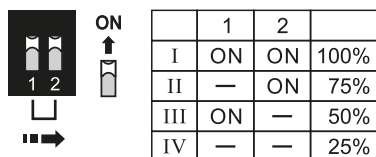

### 🕒<sup>B</sup> Doba orientačního osvětlení

Během této doby bude svítidlo vydávat slabé osvětlení (20%). Při volbě + ∞ svítidlo vydává 20% osvětlení vždy, pokud není zaznamenán pohyb. Lze nastavit pomocí přepínačů na senzoru, viz náčrty níže.

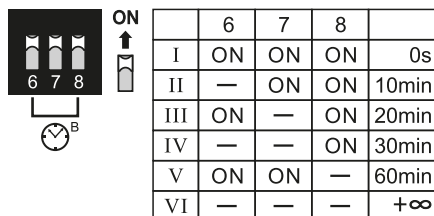

### ☀️<sup>2</sup> Režim denního osvětlení 2

Tato funkce lze spustit pouze v módu 2.

Svítidlo vydá slabé osvětlení při denním osvětlení.

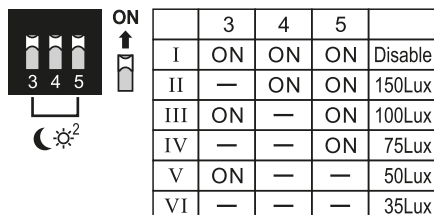

### 🕒<sup>A</sup> Doba plného osvětlení

Tato funkce definuje čas, po který svítidlo vydává 100% osvětlení a je nastavitelná pomocí přepínačů na senzoru, viz náčrty níže. Při instalaci je vhodné dobu spuštění vyzkoušet průchodem pod senzorem pro zvolení vhodného nastavení.

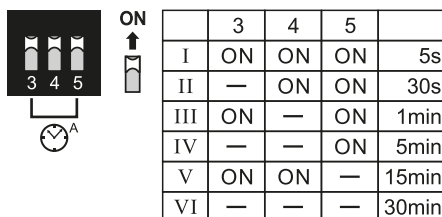

### ☀️<sup>1</sup> Režim denního osvětlení 1

Tato funkce umožňuje zapnutí senzoru v závislosti na intenzitě denního osvětlení. Plné denní osvětlení (15 Lux), přitmy (10 Lux), po setmění (5 Lux). Také možnost vypnutí senzoru. Při vyšší intenzitě denního osvětlení než bylo zvoleno na senzoru, zůstane svítidlo vypnuté i při zaznamenání pohybu.

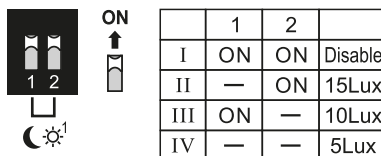

### Ⓜ Mód

Mód 1: Svítidlo zůstane vypnuté při detekci pohybu pokud intenzita denního osvětlení přesahuje hodnotu nastavenou jako "Režim denního osvětlení 1".

Mód 2: Pokud intenzita denního osvětlení klesne pod hodnotu nastavenou jako "Režim denního osvětlení 2", svítidlo vydá slabé osvětlení. Při detekci pohybu zvýší osvětlení na 100%.

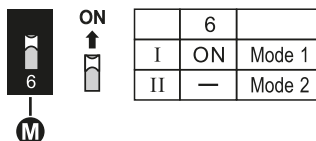

# NASTAVENÍ PARAMETRŮ MV SENZORU

## A 0% / 100% / 20%

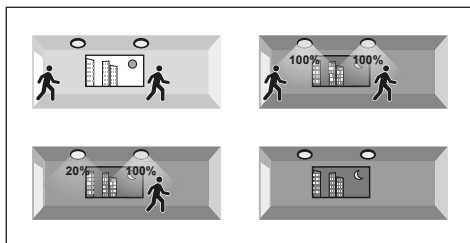

**M** Mód

6	
I	ON Mode 1
II	— Mode 2

**Doba osvětlení**

ON	6	7	8	
I	ON	ON	ON	0s
II	—	ON	ON	10min
III	ON	—	ON	20min
IV	—	—	ON	30min
V	ON	ON	—	60min
VI	—	—	—	+∞

## B 0% / 100%

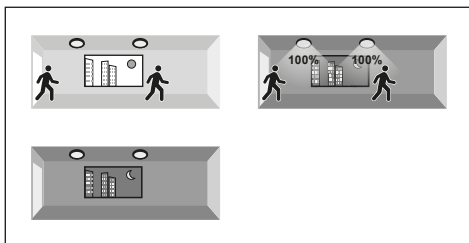

**M** Mód

6	
I	ON Mode 1
II	— Mode 2

**Doba osvětlení**

ON	6	7	8	
I	ON	ON	ON	0s
II	—	ON	ON	10min
III	ON	—	ON	20min
IV	—	—	ON	30min
V	ON	ON	—	60min
VI	—	—	—	+∞

## C 20% / 100%

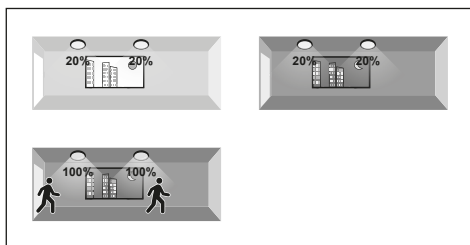

**M** Mód

6	
I	ON Mode 1
II	— Mode 2

**Doba osvětlení**

ON	6	7	8	
I	ON	ON	ON	0s
II	—	ON	ON	10min
III	ON	—	ON	20min
IV	—	—	ON	30min
V	ON	ON	—	60min
VI	—	—	—	+∞

## D 0% / 20% v závislosti na denním osvětlení / 100% při detekci pohybu

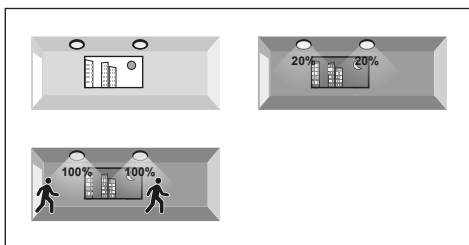

**M** Mód

6	
I	ON Mode 1
II	— Mode 2

## FUNKCE MASTER/SLAVE

### Funkce A

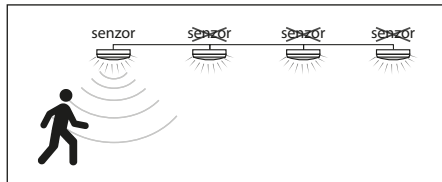

### Funkce B

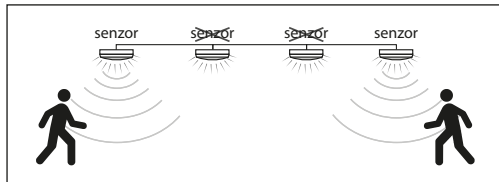

### Funkce A - Centrální spínání

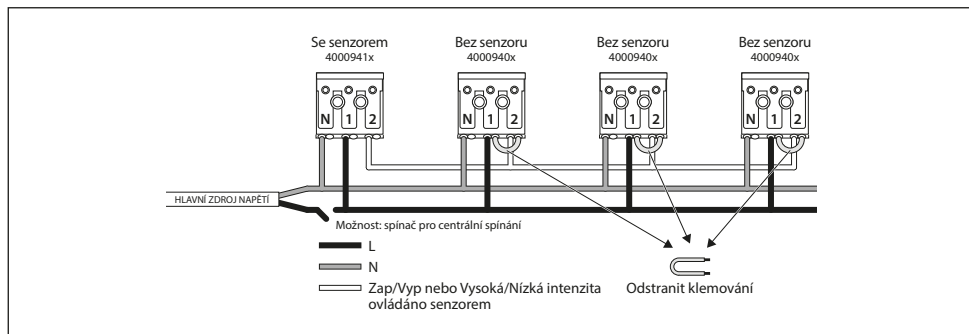

### Funkce B - Spínání pouze pomocí vestavěných čidel

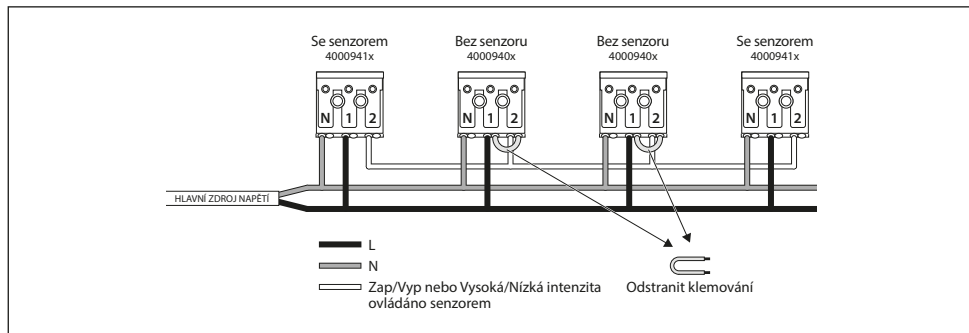

Počet svítidel ve funkci Slave je omezen (max. 60 ks).

NL

EN

FR

CZ

DE

## MONTÁŽ

1. Demontujte difuzor a desku s LED diodami.
2. Protáhněte přívodní kabel otvorem v krytu svítidla.
3. Umístěte svítidlo na požadované místo a zafixujte.
4. Správně zapojte kabel ke svorce.
5. Nasadte zpět difuzor a desku s diodami.

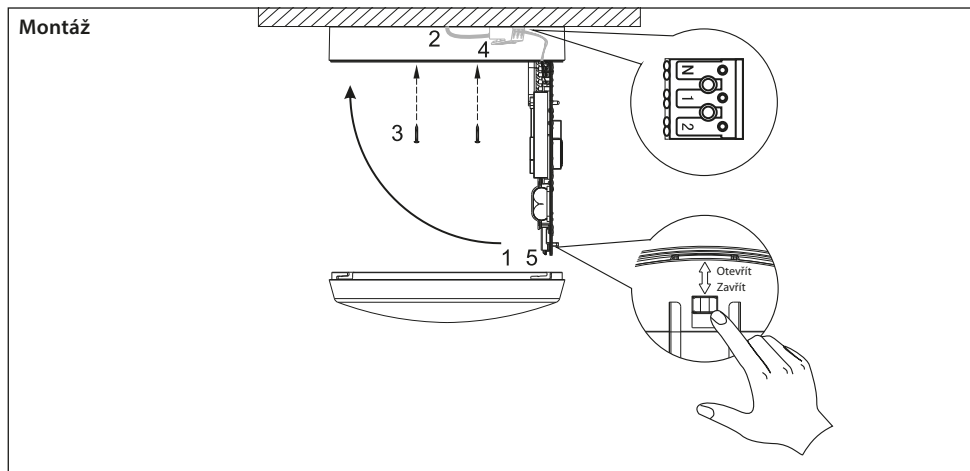

### 4 Připojení vodičů

HLAVNÍ ZDROJ NAPĚTÍ

Odstranit ve funkci Master/Slave

Bez senzoru

HLAVNÍ ZDROJ NAPĚTÍ

Se senzorem  
(bez spínače)

## VOLITELNÁ TEPLOTA CHROMATIČNOSTI

K dispozici 2 možnosti nastavení teploty chromatičnosti pomocí přepínače umístěného přímo na svítidle. Přepínač je umístěn vedle LED modulu a je dostupný po odstranění ochranného krytu.

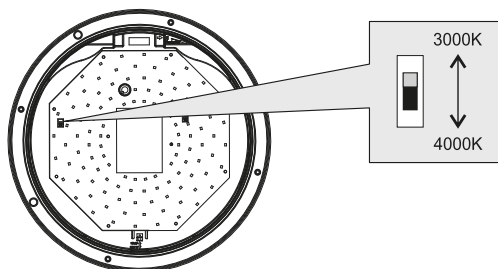

## MOŽNOSTI NASTAVENÍ SVÍTIVOSTI

Možnost nastavení 2-3 úrovní jasu ovládané přepínačem na LED panelu. Přepínač je umístěn vedle LED modulu a je dostupný po odstranění ochranného krytu.

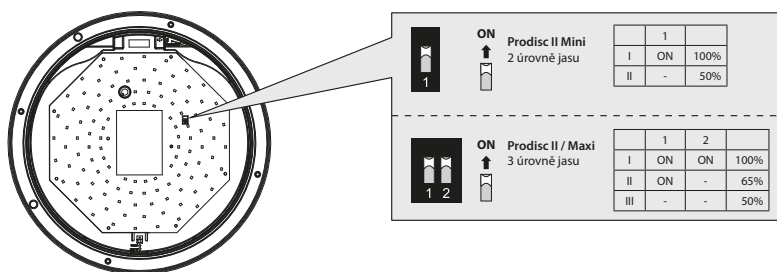

## ÚDRŽBA

1. Nejprve vypněte přívod proudu.
2. Nedotýkejte se LED diod při údržbě ani čištění.
3. Nepoužívejte chemické čisticí prostředky.

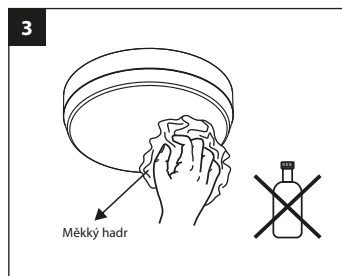
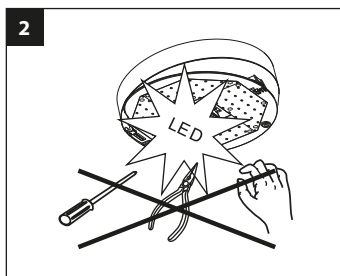
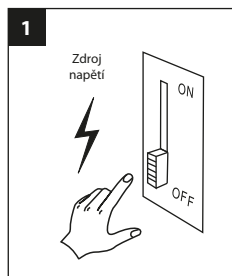

## OCHRANA ŽIVOTNÍHO PROSTŘEDÍ

Vyřazené elektronické přístroje nepatří do směsného odpadu. Prosíme recyklujte na místech tomu určených. Případně se poraďte s místním úřadem nebo svým prodejcem.



## ACHTUNG

Lesen Sie die folgende Anleitung bitte aufmerksam durch, um eine korrekte Ausführung der Montage zu gewährleisten. Bewahren Sie diese Anleitung zum späteren Nachschlagen gut auf.

## HINWEIS

1. Das Produkt muss durch einen qualifizierten Techniker installiert werden. Die Installation muss, vor der Montage, bei abgeschalteter Versorgungsspannung vorgenommen werden.
2. Die Leitung zur Spannungsversorgung muss einen Mindestquerschnitt von 2x 1,0 mm<sup>2</sup> aufweisen und entsprechend den neusten IEE-Vorschriften oder den nationalen Vorschriften angeschlossen sein.
3. Elektronische Schaltung und zugehörige Teile nicht berühren.
4. LEDs bei Installation und Wartung nicht berühren.
5. Dieses Produkt enthält eine Lichtquelle der Energieeffizienzklasse D.

## TECHNISCHE DATEN

Betriebsspannung: AC 220-240V 50/60Hz

Lichtquelle: LED SMD2835

Betriebstemperatur: -20°C – +50°C (Standard) /  
-20°C – +40°C (MW-Sensor)

Farbtemperatur wählbar: 3000K / 4000K

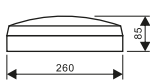

Prodisc II Mini

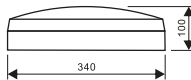

Prodisc II

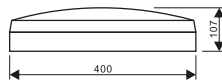

Prodisc II Maxi

## TECHNISCHE INFORMATIONEN

Artikelnr.	Betriebsspannung	LED-Typ	Leistung	Max. lichtstrom	Sensor
40009441	220-240V 50/60Hz	SMD2835	9W	900Lm	-
40009451	220-240V 50/60Hz	SMD2835	10W	900Lm	Ja
40009401	220-240V 50/60Hz	SMD2835	14W	1500Lm	-
40009411	220-240V 50/60Hz	SMD2835	15W	1500Lm	Ja
40009461	220-240V 50/60Hz	SMD2835	24W	3000Lm	-
40009471	220-240V 50/60Hz	SMD2835	25W	3000Lm	Ja

## MIKROWELLEN-SENSOR - BESCHREIBUNG

Ansprechempfindlichkeit: 25% - 100%, einstellbar

Tageslicht 1: 5 - 15Lux, einstellbar oder ausschalten

Tageslicht 2: 35 - 150Lux, einstellbar oder ausschalten (bei Tageslichtergänzung)

Nachlaufzeit: 5 - 30s - 1 - 5 - 15 - 30 Minuten (einstellbar)

Nachlaufzeit Orientierungsbeleuchtung:  
0 - 10 - 20 - 30 - 60 - ∞ Minuten (einstellbar)

Montagehöhe max. 6 m

Bewegungserkennung: 0,3 bis 3m/s

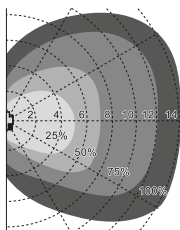

Ansbereich Wandmontage (Einheit: m)  
Empfohlene Montagehöhe: 2m

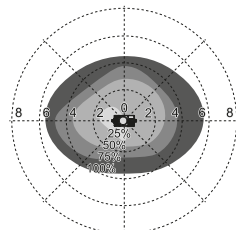

Ansbereich Deckenmontage (Einheit: m)  
Empfohlene Montagehöhe: 3m

## MIKROWELLEN-SENSOR - EINSTELLEN DER PARAMETER

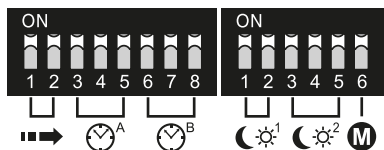

### Ansprechbereich

Diese Einstellung bestimmt den Ansprechbereich des Bewegungsmelders. Hierzu dienen die DIP-Schalter am Sensor, siehe Abbildung unten. Beachten Sie bitte, dass sich bei geringerer Empfindlichkeit auch der Ansprechbereich verkleinert.

	1	2	
I	ON	ON	100%
II	—	ON	75%
III	ON	—	50%
IV	—	—	25%

### Nachlaufzeit

Dies ist die Zeit, während der die Leuchte mit 100% Helligkeit leuchtet. Die Einstellung erfolgt an den DIP-Schaltern am Sensor, siehe Abbildung unten. Während der Installation der Leuchte ist die Einstellung Laufzeit (5s) eine praktische Hilfe, um die korrekte Funktion im gewünschten Bereich zu überprüfen.

	3	4	5	
I	ON	ON	ON	5s
II	—	ON	ON	30s
III	ON	—	ON	1min
IV	—	—	ON	5min
V	ON	ON	—	15min
VI	—	—	—	30min

### Nachlaufzeit, Orientierungsbeleuchtung

Während dieser Zeit leuchtet die Leuchte mit niedriger Helligkeit (20%). Wenn hier der Wert  $+\infty$  eingestellt ist, brennt die Leuchte ständig mit einer Helligkeit von 20%, wenn keine Bewegung erkannt wird. Die Einstellung erfolgt an den DIP-Schaltern am Sensor, siehe Abbildung unten.

	6	7	8	
I	ON	ON	ON	0s
II	—	ON	ON	10min
III	ON	—	ON	20min
IV	—	—	ON	30min
V	ON	ON	—	60min
VI	—	—	—	$+\infty$

### Tageslicht 1

Hierbei schaltet der Sensor die Leuchte ein, wenn in der Umgebung helles Tageslicht (15Lux), wenig Tageslicht (10Lux) oder fast Dunkelheit (5Lux) herrscht. Der Sensor kann hier auch ausgeschaltet werden. Solange die Helligkeit oberhalb des eingestellten Werts liegt, schaltet die Leuchte bei erkannter Bewegung nicht ein.

	1	2	
I	ON	ON	Disable
II	—	ON	15Lux
III	ON	—	10Lux
IV	—	—	5Lux

### Tageslicht 2

Dies gilt nur in Modus 2. Es handelt sich um die Tageslichthelligkeit, bei der die Leuchte mit niedriger Helligkeit leuchtet.

	3	4	5	
I	ON	ON	ON	Disable
II	—	ON	ON	150Lux
III	ON	—	ON	100Lux
IV	—	—	ON	75Lux
V	ON	—	—	50Lux
VI	—	—	—	35Lux

### Modus

Modus 1: Die Leuchte schaltet bei erkannter Bewegung nicht ein, wenn die Helligkeit des Tageslichts über dem bei "Tageslicht 1" eingestellten Wert liegt.

Modus 2: Falls die Helligkeit des Tageslichts unter den bei "Tageslicht 2" eingestellten Wert absinkt arbeitet die Leuchte mit niedriger Helligkeit. Bei erkannter Bewegung wird auf 100% umgeschaltet.

	6	
I	ON	Mode 1
II	—	Mode 2

# MIKROWELLEN-SENSOR - EINSTELLEN DER PARAMETER

## A 0% / 100% / 20%

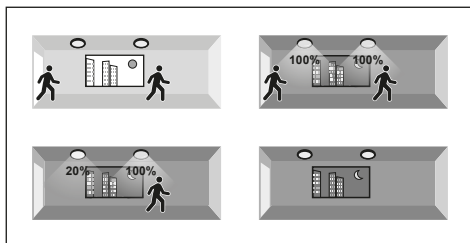

**M** Modus 

ON	6	
I	ON	Mode 1
II	—	Mode 2

 ✓

**Nachlaufzeit**

ON	6	7	8	
I	ON	ON	ON	0s
II	—	ON	ON	10min
III	ON	—	ON	20min
IV	—	—	ON	30min
V	ON	ON	—	60min
VI	—	—	—	+∞

 ✓

## B 0% / 100%

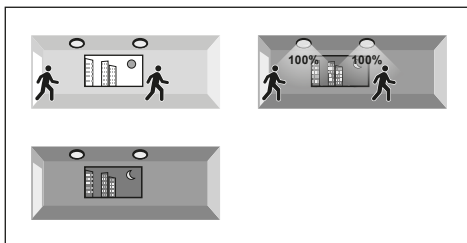

**M** Modus 

ON	6	
I	ON	Mode 1
II	—	Mode 2

 ✓

**Nachlaufzeit**

ON	6	7	8	
I	ON	ON	ON	0s
II	—	ON	ON	10min
III	ON	—	ON	20min
IV	—	—	ON	30min
V	ON	ON	—	60min
VI	—	—	—	+∞

 ✓

## C 20% / 100%

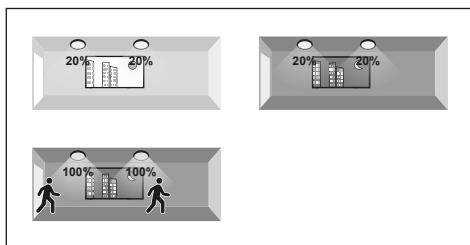

**M** Modus 

ON	6	
I	ON	Mode 1
II	—	Mode 2

 ✓

**Nachlaufzeit**

ON	6	7	8	
I	ON	ON	ON	0s
II	—	ON	ON	10min
III	ON	—	ON	20min
IV	—	—	ON	30min
V	ON	ON	—	60min
VI	—	—	—	+∞

 ✓

## D 0% / 20% je nach Tageslicht / 100% bei Bewegung

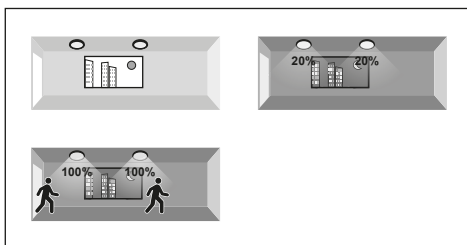

**M** Modus 

ON	6	
I	ON	Mode 1
II	—	Mode 2

 ✓



## MASTER/SLAVE FUNKTION

### Funktion A

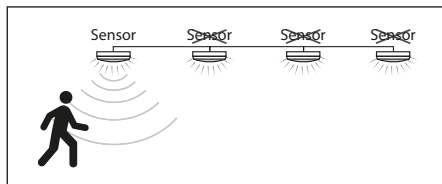

### Funktion B

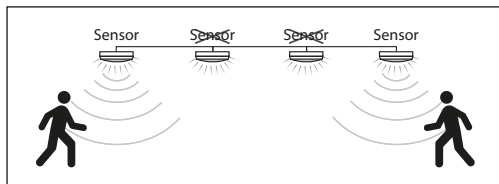

### Funktion A - Zentral geschaltet

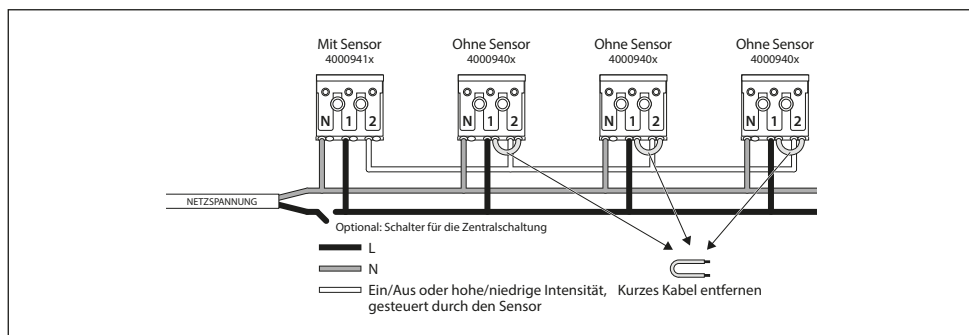

### Funktion B - Nur über eingebaute Sensoren schaltbar

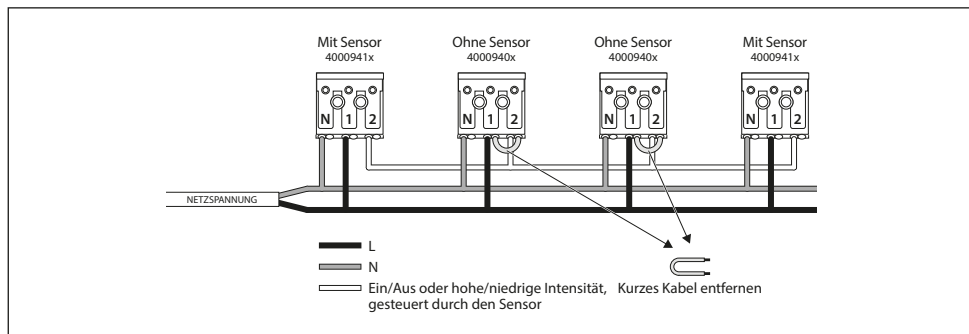

 Die Anzahl der Slaves ist begrenzt (max. 60 Stück).

## MONTAGE

1. Schrauben Sie die Blende ab und öffnen Sie das LED-Panel.
2. Führen Sie das Anschlusskabel durch die Tülle und fixieren Sie es mit der Zugentlastung.
3. Befestigen Sie die Leuchte mit Schrauben auf der Montagefläche.
4. Schließen Sie das Anschlusskabel korrekt an den Klemmen an.
5. Schließen Sie das LED-Panel und befestigen Sie die Blende.

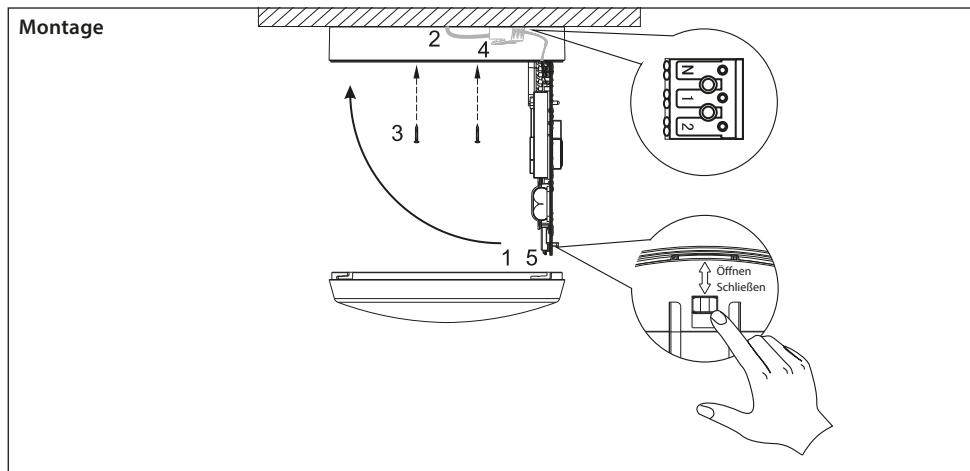

### 4 Anschluss des Kabels

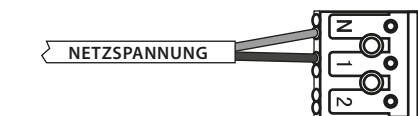

Mit Sensor  
(geschaltete Phase nicht unbedingt erforderlich)

## AUSWAHL DER FARBTEMPERATUR

Es gibt 2 mögliche Farbtemperaturen, die über einen Schalter auf dem LED-Panel eingestellt werden können. Der Schalter befindet sich auf dem LED-Panel und wird nach Abnehmen der Blende zugänglich.

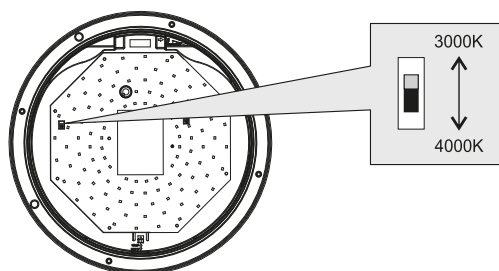

## AUSWAHL DER HELLIGKEIT

Sie können an der Leuchte zwei oder drei verschiedene Lumen-Werte einstellen. Der Schalter befindet sich neben dem LED-Modul und wird nach Abnehmen der Blende zugänglich.

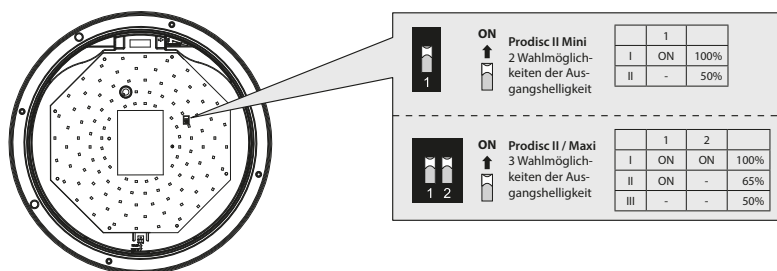

## WARTUNG

1. Spannungsversorgung der Leuchte unterbrechen.
2. LEDs bei Installation und Wartung nicht berühren.
3. Zur Reinigung der Leuchte keine Chemikalien verwenden.

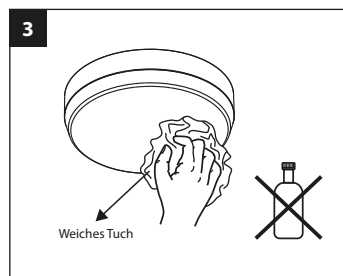
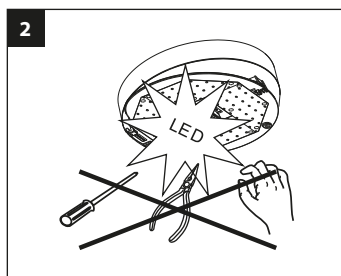
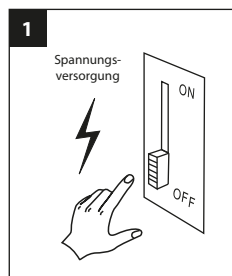

## UMWELTSCHUTZ

Defekte Elektrogeräte dürfen nicht über den Hausmüll entsorgt werden. Führen Sie sie, falls möglich, dem Recycling zu. Für weitere Hinweise zum Recycling wenden Sie sich bitte an Ihre Gemeinde oder Ihren Lieferanten.



# PROLUMIA®

## IMPORTER

### **NEDELKO B.V.**

Riga 10

2993 LW BARENDRECHT

**T** +31 (0)180 64 54 00

**E** info@nedelko.nl

### **NEDELKO BELGIUM NV**

Prins Boudewijnlaan 49

2650 EDEGEM

**T** +32 (0)3 826 99 99

**E** info@nedelko.be

### **NEDELKO S.R.O.**

Ke Slivenci 48

154 00 PRAHA 5 - LOCHKOV

**T** +420 222 563 003

**E** info@nedelko.cz

### **NEDELKO GERMANY GMBH**

Heinz-Bäcker-Str. 27

45356 ESSEN

**T** +49 (0)201 560503 50

**E** info@nedelko.de