







THE ESSENTIAL

DEFINITIONS

 Protection sign according to IEC/EN 60529	1st digit for solid 4 = protects against solid bodies/ tools 1mm 5 = protects against dust 6 = dustproof	2nd digit for liquids 4 = splash resistant 5 = protected against jets of water 6 = completely protected against powerful water jets (fire hose) 7 = protected against the effects of temporary immersion 8 = Protected against effects of prolonged immersion under specified conditions 9 = Protected against high pressure jets
 Index of resistance to mechanical shocks according to IEC/EN 62262	IK08 = withstands a shock of 1.7 kg to 30 cm (5 joules) IK09 = withstands a shock of 5 kg to 20 cm (10 joules) IK10 = withstands a shock of 5 kg to 40 cm (20 joules)	
 Switching capacity according to IEC/EN 60947-3	AC 21 = Resistive on load breaking (simple switchgear, lighting) AC 22 = Mix resistive and inductive on load breaking AC 23 = High inductive on load breaking (motor)	

HAZARDOUS AREA CERTIFICATION

ATEX 	Certification according to European directive 2014/34/EU on all equipment used in or related to explosive atmospheres.
IECEX	Complying with international standards for electrical and non-electrical equipment for use in explosive atmospheres.

Probability of ATEX presence	Very High	High and Normal	Low
Zoning for gas & vapours	Zone 0	Zone 1	Zone 2
Zoning for dust & fiber	Zone 20	Zone 21	Zone 22

Performance level of the MARECHAL® devices.



**Our switch rated
socket-outlets
offer you safety and
time saving.**

SUMMARY



For more than 65 years MARECHAL® has been the brand of low voltage electrical connectors designed, manufactured and controlled in France in strict compliance with the requirements of international standards (IEC and UL).

Thanks to the butt-contact technology, the dozens of patents (filed in more than 50 countries) and the choice of the highly advanced materials, MARECHAL® connectors are the most reliable in the world.

They guarantee the best safety for users and equipment in accordance with the requirements of the European Low Voltage Directive (LVD no. 2014/35/EU).

OUR TECHNOLOGY	4
OUR UNIQUE ADVANTAGES	5
OUR SOLUTIONS :	
16-20 A	6
32 A	7
63 A	8
80-100 A	9
125-150 A	10
200-250 A	11
MULTICONTACT FROM 7 TO 37 PIN	12-13
COMPACT SOCKET 16-30 A	14
INDUSTRIAL BOXES	15
SINGLE POLE POWER CONNECTOR FROM 400 TO 700 A	16
HEAVY-DUTY PLUGS & SOCKETS FROM 315 TO 600 A	17
HAZARDOUS AREA BOXES	18
ENERGY EFFICIENCY	19
OPTIONS	20-21



OUR TECHNOLOGY

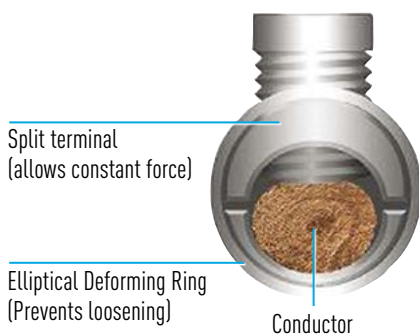
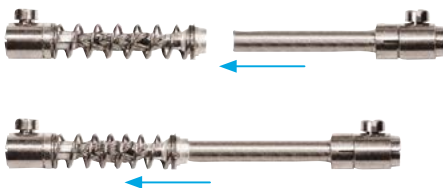

DECONTACTOR™, A ONE OF A KIND DESIGN IN THE WORLD

The DECONTACTOR™ is a connector which combines

- the advantages of a **power socket**,
- and the performance of a **switch**.

With more than 65 years of research and innovations behind it, the DECONTACTOR™ range offers a level of reliability and safety never yet equalled in the world. It allows you to connect and disconnect devices thousands of times in the most severe environments in perfect safety for the user!

BUTT STYLE CONTACT ON A SILVER-NICKEL TIP

The MARECHAL® DECONTACTOR™ and connectors are all fitted with butt style contacts with silver-nickel tips. They provide exceptional connection quality by eliminating the damage due to electric arcs and wear seen with pin and sleeve sockets. Silver is an excellent conductor of current even when oxidized. Conductivity is optimal even in the presence of vibration and temperature variation thanks to the pressure of the springs.

CRIMPED BRAIDS

The MARECHAL® contact uses a crimped braid with a spring which provides contact performance and tolerances superior to pin and sleeve contacts. The flexibility of the braid and the spring allows the base contact tip to always be perfectly aligned with the plug contact tip. These contacts, which are silver and anti-corrosion treated, offer very good corrosion resistance.

ELASTIC LOCK TERMINALS

MARECHAL® contacts are fitted with «elastic lock» connection terminals. The wire clamp is split and surrounded by an elliptical deforming ring. This method allows the tightening force on the wire to be constant. Hence despite the creep of the copper or aluminium, the variations of temperature and vibration, the conductor wire is perfectly connected to the contact terminal.

SAFETY SHUTTER

DECONTACTOR™ sockets are fitted with an interlocked safety shutter which prevents access to live contacts. This shutter only unlocks at the time of connection of the plug into its base.

CASING MADE FROM ADVANCED MATERIALS

MARECHAL® range connectors and DECONTACTOR™ have casings made from fibre glass- or metal-reinforced GRP, depending on the models. This choice of material contributes to the excellent mechanical performance and longevity of the socket.



A UNIQUE TECHNOLOGY WITH UNIQUE ADVANTAGES

MARECHAL TECHNOLOGY

THE ADVANTAGES

DECONTACTOR™,
switch + rated socket-outlet up to 250 A



Avoids contactor installation & purchase, as well as pilots wiring.
The only coupler socket that offers on load breaking without pilots wires.

Safety shutter



No access to live parts.

Switching capacity AC-22/AC-23



Reduce production downtime & maintenance cost.

LOTO ready



Local motor visible switching.

Automatic waterproofness IP66/IP67/
IP69 lid closed or plug connected



Automatic sealing without rotating ring.
Resistant to high pressure cleaning.

ATEX/IECEX



Secure load breaking & simplify maintenance in hazardous area.

T_{amb} -40 °C/+60 °C



Resistant to severe climatic conditions.

Dual voltage 230 V/400 V



A single socket 3+P+N+E can receive several configurations: PNE; 3PE; 3PNE.

GRP IK08/METAL IK09



Ensures a much longer service life than plastic materials.

Silvered butt style contact with silver-nickel tip



Exceptional connection quality.
No corrosion phenomenon unlike copper or brass contacts.
Low heating = lower electricity consumption.

Our devices are also certified to UL, CSA, BV MARINE, EAC, etc.



Easy integration into your machines for export.

Up to 24 keying positions



Identifies and secures your dedicated networks.
Prevents cross-connection.

MARECHAL MODULARITY



Active part	Socket-outlet	Socket-outlet	Socket-outlet	Socket-outlet	Appliance inlet	Appliance inlet
Mounting accessories	/	Inclined sleeve	Wall box	Handles	Handles	/

16-20 A



DSN1

DECONTACTOR™ SWITCH + SOCKET-OUTLET



Voltages	Pole configuration	Panel mounted Socket	Inclined socket	Wall mounting socket	Coupler socket	Plug	Appliance inlet
220-250 V AC	1P+N+E + accessories	6114015 /	6114015 511M3	6114015 511B3M20 ⁽¹⁾	6114015 511P0D18 ⁽²⁾	6118015 511P0D18 ⁽²⁾	6118015 /
380-440 V AC	3P+E + accessories	6114013 /	6114013 511M3	6114013 511B3M20 ⁽¹⁾	6114013 511P0D18 ⁽²⁾	6118013 511P0D18 ⁽²⁾	6118013 /
220-250 V AC	3P+N+E + accessories	6114017 /	6114017 511M3	6114017 511B3M20 ⁽¹⁾	6114017 511P0D18 ⁽²⁾	6118017 511P0D18 ⁽²⁾	6118017 /

(1) M20 threading - (2) Gland size 9-18 mm.



DXN1

DECONTACTOR™ SWITCH + SOCKET-OUTLET



II 2 G D Ex de IIC T6/T5 Ex tb IIIC T70 °C/T90 °C



i IK09 METAL version available

Voltages	Pole configuration	Panel mounted Socket	Inclined socket	Wall mounting socket	Coupler socket	Plug	Appliance inlet
220-250 V AC	1P+N+E + accessories	2514015 /	2514015 251A057	2514015 251AB53 ⁽¹⁾	2514015 251A753 ⁽¹⁾	2518015 251A753 ⁽¹⁾	2518015 /
380-440 V AC	3P+E + accessories	2514013 /	2514013 251A057	2514013 251AB53 ⁽¹⁾	2514013 251A753 ⁽¹⁾	2518013 251A753 ⁽¹⁾	2518013 /
380-440 V AC	3P+N+E + accessories	2514017 /	2514017 251A057	2514017 251AB53 ⁽¹⁾	2514017 251A753 ⁽¹⁾	2518017 251A753 ⁽¹⁾	2518017 /

(1) Gland size 10-14 mm.

ACCESSORIES AND OPTIONS



DECONTACTOR™	Industrial/domestic adapters	Inlet cap IP66/IP67	Self-returning lid (without full closure IP40)	Locking pin for 2 padlocks Ø 8 mm (padlocks not supplied)
DSN1	6118015D40	611A426	Socket ref. + R	Socket ref. + 843
DXN1	/	/	Socket ref. + R	Socket ref. + 843

32 A



DSN3

DECONTACTOR™ SWITCH + SOCKET-OUTLET



Voltages	Pole configuration						
		Panel mounted Socket	Inclined socket	Wall mounting socket	Coupler socket	Plug	Appliance inlet
220-250 V AC	1P+N+E + accessories	6134015 /	6134015 512M3	6134015 512B3M20 ⁽¹⁾	6134015 512P0D21 ⁽²⁾	6138015 512P0D21 ⁽²⁾	6138015 /
380-440 V AC	3P+E + accessories	6134013 /	6134013 512M3	6134013 512B3M20 ⁽¹⁾	6134013 512P0D21 ⁽²⁾	6138013 512P0D21 ⁽²⁾	6138013 /
220-250 V AC	3P+N+E + accessories	6134017 /	6134017 512M3	6134017 512B3M20 ⁽¹⁾	6134017 512P0D21 ⁽²⁾	6138017 512P0D21 ⁽²⁾	6138017 /
380-440 V AC							

(1) M20 threading - (2) Gland size 5-21 mm.



DXN3

DECONTACTOR™ SWITCH + SOCKET-OUTLET



II 2 G D Ex de IIC T6/T5 Ex tb IIIC T57°C/T77°C

Voltages	Pole configuration						
		Panel mounted Socket	Inclined socket	Wall mounting socket	Coupler socket	Plug	Appliance inlet
220-250 V AC	1P+N+E + accessories	2534015 /	2534015 253A027	2534015 253AB53 ⁽¹⁾	2534015 253A783 ⁽²⁾	2538015 253A783 ⁽²⁾	2538015 /
380-440 V AC	3P+E + accessories	2534013 /	2534013 253A027	2534013 253AB53 ⁽¹⁾	2534013 253A783 ⁽²⁾	2538013 253A783 ⁽²⁾	2538013 /
380-440 V AC	3P+N+E + accessories	2534017 /	2534017 253A027	2534017 253AB53 ⁽¹⁾	2534017 253A783 ⁽²⁾	2538017 253A783 ⁽²⁾	2538017 /

(1) Gland size 10-14mm - (2) Gland size 12-18 mm.

ACCESSORIES AND OPTIONS



DECONTACTOR™	Industrial/domestic adapters	Inlet cap IP66/IP67	Self-returning lid (without full closure IP40)	Locking pin for 2 padlocks Ø 8 mm (padlocks not supplied)
DSN3	6138015D40	613A426	Socket ref. + R	Socket ref. + 843
DXN3	/	253A426	Socket ref. + R	Socket ref. + 843



DECONTACTOR™ SWITCH + SOCKET-OUTLET



Voltages	Pole configuration	Panel mounted Socket	Inclined socket	Wall mounting socket	Coupler socket	Plug	Appliance inlet
220-250 V AC	1P+N+E + accessories	6164015 /	6164015 513M3	6164015 513B3M25 ⁽¹⁾	6164015 513P0D30 ⁽²⁾	6168015 513P0D30 ⁽²⁾	6168015 /
380-440 V AC	3P+E + accessories	6164013 /	6164013 513M3	6164013 513B3M25 ⁽¹⁾	6164013 513P0D30 ⁽²⁾	6168013 513P0D30 ⁽²⁾	6168013 /
220-250 V AC	3P+N+E + accessories	6164017 /	6164017 513M3	6164017 513B3M25 ⁽¹⁾	6164017 513P0D30 ⁽²⁾	6168017 513P0D30 ⁽²⁾	6168017 /

(1) M25 threading - (2) Gland size 10-30 mm.



DECONTACTOR™ SWITCH + SOCKET-OUTLET



II 2 G D Ex de IIC T6/T5 Ex tb IIIC T87°C/T107°C

Voltages	Pole configuration	Panel mounted Socket	Inclined socket	Wall mounting socket	Coupler socket	Plug	Appliance inlet
220-250 V AC	1P+N+E + accessories	2564015 /	2564015 256A027	2564015 256AB8840P ⁽¹⁾	2564015 256A753 ⁽²⁾	2568015 256A753 ⁽²⁾	2568015 /
380-440 V AC	3P+E + accessories	2564013 /	2564013 256A027	2564013 256AB8840P ⁽¹⁾	2564013 256A753 ⁽²⁾	2568013 256A753 ⁽²⁾	2568013 /
380-440 V AC	3P+N+E + accessories	2564017 /	2564017 256A027	2564017 256AB8840P ⁽¹⁾	2564017 256A753 ⁽²⁾	2568017 256A753 ⁽²⁾	2568017 /

(1) Gland size 22-32 mm - (2) Gland size 12-18 mm.

ACCESSORIES AND OPTIONS



In-line connections
(a pair of finger draw plates to aid closing)



Inlet cap IP66/IP67



180° Opening lid



Self-returning lid
(without full closure IP40)



Locking pin for 2 padlocks
from ø 4 to 8 mm (padlocks not supplied)

DECONTACTOR™	616A346	616A426	Socket ref. + 10	Socket ref. + R	Socket ref. + 843
DSN6	616A346	616A426	Socket ref. + 10	Socket ref. + R	Socket ref. + 843
DXN6	616A346	256A426	Socket ref. + 10	Socket ref. + R	Socket ref. + 843

80-100 A



DECONTACTOR™ SWITCH + SOCKET-OUTLET



90 A



IP54/IP55



GRP



IK08



-40°C
+60°C



AC-22
AC-23



IK09 METAL version available



Voltages	Pole configuration	Panel mounted Socket	Inclined socket	Wall mounting socket	Coupler socket	Plug	Appliance inlet
220-250 V AC	1P+N+E + accessories	3164015* /	3164015* 514M3	3164015* 514B3M40 ⁽¹⁾	3164015* 514POD35 ⁽²⁾	3168015* 514POD35 ⁽²⁾	3168015* /
380-440 V AC	3P+E + accessories	3164013* /	3164013* 514M3	3164013* 514B3M40 ⁽¹⁾	3164013* 514POD35 ⁽²⁾	3168013* 514POD35 ⁽²⁾	3168013* /
220-250 V AC 380-440 V AC	3P+N+E + accessories	3164017* /	3164017* 514M3	3164017* 514B3M40 ⁽¹⁾	3164017* 514POD35 ⁽²⁾	3168017* 514POD35 ⁽²⁾	3168017* /

(1) M40 threading - (2) Gland size 13-35 mm.

* For 100 A version add suffix **-228**, for IP66/IP67 version add suffix **-600**.



Self-closing lid version available

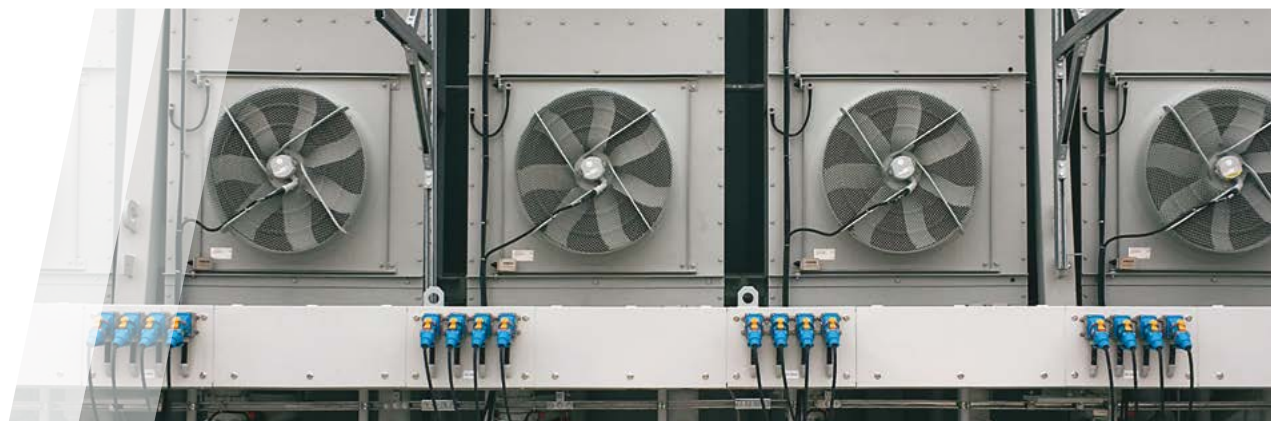

ACCESSORIES AND OPTIONS



In-line connections
(a pair of finger draw plates to aid closing)

316A346



Inlet cap IP66/IP67

316A426



Locking pin for 2 padlocks from 4 to 8 mm (padlocks not supplied)

Socket ref. + 843

DECONTACTOR™

DS6

125-150 A

DS9

DECONTACTOR™ SWITCH + SOCKET-OUTLET



150 A	IP66/IP67 IP69	GRP	IK08	-40°C +60°C	AC-22 AC-23

i IK09 METAL version available



Voltages	Pole configuration	Panel mounted Socket	Inclined socket	Wall mounting socket	Coupler socket	Plug	Appliance inlet
380-440 V AC	3P+E + accessories	3194013 /	3194013 515M3	3194013 595C3M40 ⁽¹⁾	3194013 555P0D35 ⁽²⁾	3198013 555P0D35 ⁽²⁾	3198013 /
220-250 V AC	3P+N+E + accessories	3194017 /	3194017 515M3	3194017 595C3M40 ⁽¹⁾	3194017 555P0D35 ⁽²⁾	3198017 555P0D35 ⁽²⁾	3198017 /
380-440 V AC							

(1) M40 threading - (2) Gland size 25-35 mm.

DX9

DECONTACTOR™ SWITCH + SOCKET-OUTLET



II 2 G D Ex de IIC T6/5 tD A21 T80°C/90 °C

125 A	IP65/IP66	METAL	IK10	-25°C +60°C	AC-22



Voltages	Pole configuration	Wall mounting socket	Coupler socket	Plug
380-440 V AC	3P+E + accessories	2694013 269AB5350M ⁽¹⁾	2694013 269A95350M ⁽¹⁾	2691013 ⁽²⁾ /
380-440 V AC	3P+N+E + accessories	2696017 269AB5350M ⁽¹⁾	2694017 269A95350M ⁽¹⁾	2691017 ⁽²⁾ /

(1) Gland size 23-35 mm - (2) Gland size 16-27 mm.

ACCESSORIES AND OPTIONS



DECONTACTOR™	Locking pin for 2 padlocks 8 mm (padlocks not supplied)	Inlet cap IP55	Inlet cap IP65
DS9	Socket ref. + 844	319A126	/
DX9	Included	/	266A926

200-250 A

DS2



DECONTACTOR™ SWITCH + SOCKET-OUTLET



Voltages	Pole configuration	Panel mounted Socket	Inclined socket	Wall mounting socket	Coupler socket	Plug	Appliance inlet
380-440 V AC	3P+E + accessories	3924013 /	3924013 596M6	3924013 596E6M63 ⁽¹⁾	3924013 556POD49 ⁽²⁾	3928013 556POD49 ⁽²⁾	3928013 /
220-250 V AC	3P+N+E + accessories	3924017 /	3924017 596M6	3924017 596E6M63 ⁽¹⁾	3924017 556POD49 ⁽²⁾	3928017 556POD49 ⁽²⁾	3928017 /

(1) M63 threading - (2) Gland size 45-49 mm.

DX2



DECONTACTOR™ SWITCH + SOCKET-OUTLET



II 2 G D Ex de IIC T3 tD A21 T91°C



Voltages	Pole configuration	Wall mounting socket	Coupler socket	Plug
380-440 V AC	3P+E + accessories	2674013 267AB53 ⁽¹⁾	2674013 267A963 ⁽¹⁾	2671013 ⁽¹⁾ /
380-440 V AC	3P+N+E + accessories	2674017 267AB53 ⁽¹⁾	2674017 267A963 ⁽¹⁾	2671017 ⁽¹⁾ /

(1) Gland size 36-48 mm.

ACCESSORIES AND OPTIONS



Locking pin for 2 padlocks 8 mm (padlocks not supplied)



Inlet cap IP55



Inlet cap IP65

DECONTACTOR™	Locking pin for 2 padlocks 8 mm (padlocks not supplied)	Inlet cap IP55	Inlet cap IP65
DS2	Socket ref. + 453	312A126	/
DX2	Included	/	266A926

MULTICONTACT



PN7C

UP TO 7 PIN



16 A



IP66/IP67



GRP
METAL



IK08
IK09



-40°C
+60°C



Voltages

Pole configuration

Panel mounted Socket

Inclined socket

Wall mounting socket

Coupler socket

Plug

Appliance inlet

500 V AC	GRP	6P+E (16 A) + accessories	01P4061 /	01P4061 511M3	01P4061 511B3M20 ⁽¹⁾	01P4061 511P0D18 ⁽²⁾	01P8061 511P0D18 ⁽²⁾	01P8061 /
415 V AC	METAL	6P+E (16 A) + accessories	09P4061 /	09P4061 591M3	09P4061 591C4M20 ⁽¹⁾	09P4061 591P020M ⁽²⁾	09P8061 591P020M ⁽²⁾	09P8061 /

(1) M20 threading - (2) Gland size 9-18 mm.



PN12C

UP TO 12 PIN



16 A



IP66/IP67



GRP
METAL



IK08
IK09



-40°C
+60°C



Available in Ex

Voltages

Pole configuration

Panel mounted Socket

Inclined socket

Wall mounting socket

Coupler socket

Plug

Appliance inlet

480 V AC	GRP	12 pin + accessories	01A4001 /	01A4001 511M3	01A4001 511B3M20 ⁽¹⁾	01A4001 511P0D18 ⁽²⁾	01A8001 511P0D18 ⁽²⁾	01A8001 /
480 V AC	METAL	12 pin + accessories	09A4001 /	09A4001 591M3	09A4001 511B3M20 ⁽¹⁾	09A4001 591P020M ⁽²⁾	09A8001 591P020M ⁽²⁾	09A8001 /

(1) M20 threading - (2) Gland size 9-18 mm.

ACCESSORIES AND OPTIONS



PRODUCT

Locking with padlock
Ø 4 mm (padlocks not
supplied)

Inlet cap

180° Opening lid

Self-returning
lid (without full
closure IP40)

Bag of 13 females/
males contacts

PN7C	Socket ref. + 843	012A126	Socket ref. + 18	Socket ref. + R	/
PN12C	Socket ref. + 843	012A126	Socket ref. + 18	Socket ref. + R	01AA213 /01AA113

MULTICONCONTACT



DSN24C

UP TO 24 PIN



16 A



IP66/IP67



GRP



IK08



-40°C
+60°C



Available in



Voltages

Pole configuration

Panel mounted Socket

Inclined socket

Wall mounting socket

Coupler socket

Plug

Appliance inlet

480 V AC

24 pin
+
accessories

61B4002

61B4002

61B4002

61B4002

61B8002

61B8002

/

512M3

512C7000⁽¹⁾

512P0D21⁽²⁾

512P0D21⁽²⁾

/

(1) Without threading - (2) Gland size 5-21 mm.



DSN37C

UP TO 37 PIN



16 A



IP66/IP67



GRP



IK08



-40°C
+60°C



Available in



Voltages

Pole configuration

Panel mounted Socket

Inclined socket

Wall mounting socket

Coupler socket

Plug

Appliance inlet

480 V AC

37 pin
+
accessories

61C4003

61C4003

61C4003

61C4003

61C8003

61C8003

/

513M3

513C7000⁽¹⁾

513P0D30⁽²⁾

513P0D30⁽²⁾

/

(1) Without threading - (2) Gland size 10-30 mm.

ACCESSORIES AND OPTIONS



Locking pin for 2 padlocks ø 8 mm (padlocks not supplied)

DECONTACTOR™

DSN24C

Socket ref. + 843



Inlet cap IP66/IP67

613A426



180° Opening lid

Socket ref. + 10



Self-returning lid (without full closure IP40)

Socket ref. + R



Bag of 13 females/males contacts

01AA213/61CA113

DSN37C

Socket ref. + 843

616A426

Socket ref. + 10

Socket ref. + R

01AA213/61CA113

16 A/30 A

COMPACT SOCKET



PN

COMPACT PLUGS & SOCKETS



30 A



IP66/IP67



GRP



IK08



-40°C
+60°C



IK09 METAL version available



Voltages	Pole configuration	Panel mounted Socket	Inclined socket	Wall mounting socket	Coupler socket	Plug	Appliance inlet
220-250 V AC	1P+N+E + accessories	01N4015 /	01N4015 511M3	01N4015 511B3M20 ⁽¹⁾	01N4015 511P6D18 ⁽²⁾	01N8015 511P6D18 ⁽²⁾	01N8015 /
380-440 V AC	3P+E + accessories	01N4013 /	01N4013 511M3	01N4013 511B3M20 ⁽¹⁾	01N4013 511P6D18 ⁽²⁾	01N8013 511P6D18 ⁽²⁾	01N8013 /
220-250 V AC	3P+N+E + accessories	01N4017 /	01N4017 511M3	01N4017 511B3M20 ⁽¹⁾	01N4017 511P6D18 ⁽²⁾	01N8017 511P6D18 ⁽²⁾	01N8017 /

(1) M20 threading - (2) Gland size 9-18 mm.



PNC

COMPACT CONNECTOR



16 A



IP66/IP67



GRP



IK08



-40°C
+60°C



Voltages	Pole configuration	Panel mounted Socket	Inclined socket	Wall mounting socket	Coupler socket	Plug	Appliance inlet
480 V AC	5P+E + accessories	01E4007 /	01E4007 551M3 +251A457-E	01E4007 551B3M20 +251A457-E	01E3007 /	01E1007 /	01E8007 /

ACCESSORIES AND OPTIONS



**Locking with padlock
ø 4 mm (padlocks
not supplied)**



Inlet cap



180° Opening Lid



**Self-returning lid (without full
closure IP40)**

DECONTACTOR™	Locking with padlock ø 4 mm (padlocks not supplied)	Inlet cap	180° Opening Lid	Self-returning lid (without full closure IP40)
PN	Socket ref. + 843	012A126	Socket ref. + 18	Socket ref. + R
PNC	/	01EA126	/	/

INDUSTRIAL BOXES



CD

DISTRIBUTION BOX



Other materials and configurations available upon request.

- ▶ IP66/IP69 water-and dust-tight
- ▶ Up to 10 modules
- ▶ Up to 2x 63 A DECONTACTOR™
- ▶ Complies with IEC/EN 61439-1 and IEC/EN 61439-3
- ▶ Composed of two parts fixed on hinges
- ▶ Pre-wired
- ▶ UV protected



RETTBOX®

ELECTROMECHANICAL SELF-EJECT DECONTACTOR™



- ▶ For all types of emergency vehicles
- ▶ Self-eject DECONTACTOR™ for:
 - power supply
 - pneumatic air
- ▶ AISI 316 L stainless steel housing with electromagnetic coil (12 V DC-24 V DC)
- ▶ Automatic ejection of the coupler socket upon start-up of the vehicle



400 A/700 A

SINGLE POLE POWER CONNECTOR



CS1000

SINGLE POLE POWER CONNECTOR



400 A



IP66/IP67



GRP



IK08



-40°C
+60°C

- ▶ Up to 400 A/1 000 V
- ▶ Automatic IP66/IP67 water- and dust-tight
- ▶ Visual and mechanical coding
- ▶ Padlocking in option

Contact us for more information.



SP

SINGLE POLE POWER CONNECTOR



700 A



IP66/IP67



GRP



IK08



-40°C
+60°C

- ▶ Up to 700 A/1 000 V
- ▶ Automatic IP66/IP67 water-and dust-tight
- ▶ Electromechanical interlocking system
- ▶ Visual and mechanical coding
- ▶ Padlocking in option

Available in Ex





DS4

COMPACT HEAVY-DUTY PLUGS & SOCKETS



400 A



IP54



METAL



IK09



-40°C
+60°C

- ▶ Automatic IP54/55
- ▶ Optional IP66/IP67
- ▶ Metal casing (IK09) with epoxy paint
- ▶ With a safety shutter 3P+E +2 pilots



Contact us for more information.



PF

HEAVY-DUTY PLUGS & SOCKETS



315 A → 600 A



IP66/IP67



METAL



IK10



-40°C
+60°C

- ▶ Up to 600 A/1 000 V
- ▶ Automatic IP66/IP67 water-and dust-tight
- ▶ Mechanical and electrical interlocking
- ▶ 3P+N+E+6 auxiliaries + 2 pilots
- ▶ Metal casing and stainless steel case AISI 316 L



HAZARDOUS AREA BOXES



B2X

SOCKET OR JUNCTION BOXES



63 A



IP66/IP67



GRP



IK09



-50°C
+60°C



Contact us
for your needs

- ▶ II 2 G D Ex e IIC, Ex tb IIIC
- ▶ Intrinsic safety capability
- ▶ IP66/IP67 Water-and dust-tight
- ▶ GRP casing, exists with hinges
- ▶ With Ex e certified terminals
- ▶ Dimension 120x120x90 mm or 160x160x90 mm



MXBS

JUNCTION BOXES



680 A



IP66/IP67



METAL



IK09



-55°C
+60°C

- ▶ Intrinsic safety capability
- ▶ IP66 Water-and dust-tight
- ▶ Multi-contact connectors and socket-outlets on the same enclosure
- ▶ GRP casing, aluminium, stainless steel AISI 316 L
- ▶ From -55 °C to +60 °C



ENERGY EFFICIENCY

THE FIRST ELECTRICAL CONNECTOR THAT MAKES YOU GREEN

Our patented butt electrical contact technology is up to **5,7 times** more efficient than a standard pin and sleeve product.

TECHNICALLY DESIGNED TO LIMIT HEATING AND COMPENSATE THERMAL CYCLE

Comparative heating curve

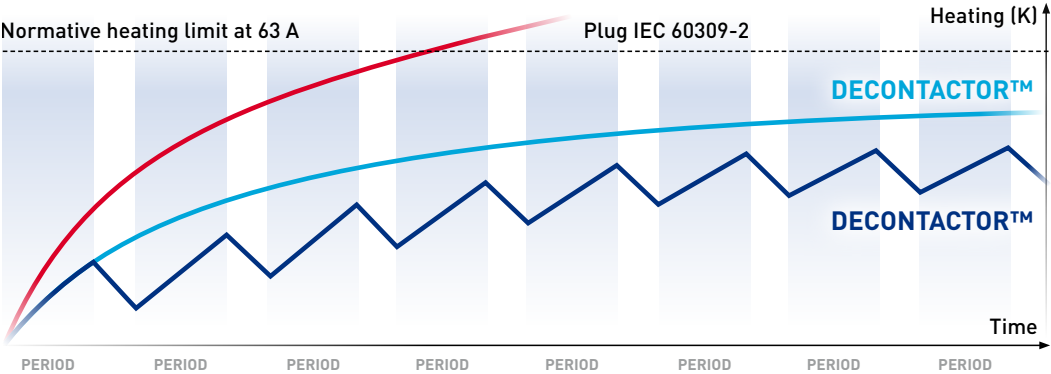

- Heating curve of a 60309-2 socket at a constant 63 A current.
- Heating curve of a DECONTACTOR™ at a constant 63 A current.
- Successive heating curves of a DECONTACTOR™ at a particular current cycle of 63 A. The DECONTACTOR™ stabilised.

PROVEN EFFICIENCY

2,5 times less resistance
(Non oxydized contact)

Up to 5,7 times less resistance
(Oxydized contact)

5 KEY BENEFITS TO REDUCE ENERGY CONSUMPTION



Energy saving



Cost saving



Less cooling needed
(in the data center case)



Less carbon
foot print



Complementary saving
dual voltage construction



OPTIONS

MECHANICAL LOCKING

Locking devices prevent the unintentional supply or use of an equipment during maintenance, and fit perfectly within consignment procedures known as LOTO (Lockout/Tag-out). Socket-outlets adjacent to electric machines or motors may be disconnected and locked-out thus providing a visible disconnection and protecting workers from a local security failure, without the use of an authorized electrician.

Socket-outlet alone



Connected assembly



Plug alone



STOP-LATCH

This option is ideal for quick disconnection of machinery and equipment by employees wearing gloves.

The latch is fitted with a red label with warning «stop» for ease of identification.

The use of this latch is not recommended in case of extension cables.



REVERSED INTERIORS

In the PN series, the interior mouldings and contacts can be swapped:

- The plug interior moulding and contacts can be assembled in a socket-outlet casing.
- The socket-outlet moulding and contacts can be assembled in plug casing.



ECONOMY OF INSTALLATION: DUAL-VOLTAGE

With a single base (e.g.: 3 PNE - 230/400 V) it is possible to feed 3 plugs indifferently:

- a 3 PNE - 400 V plug,
- a 3 PE - 400 V plug,
- a PNE - 230 V.

This compatibility provides real savings on the installation of these sockets for the user.

400 V plug - 3P+E



230 V plug - 1P+N+E

400 V plug - 3P+N+E



230/400 V socket-outlet
3P+N+E



Industrial-domestic adapter
with 1P+N+E /
230 V - 10/16 A domestic
socket

OPTIONS

ELECTROMAGNETIC COMPATIBILITY (EMC)

Most electrical and electronic equipments generate electromagnetic fields can sometimes interfere with the operation of other equipments. This option allows our metal cased devices to function properly in an electromagnetic environment without producing disturbances for everything that is in this environment, thus limiting the level of unwanted emissions from the device to not to disrupt radio reception or other equipment.

Electromagnetic compatibility (EMC) tests are carried out on our products according to IEC 62153-4-5: 2016. Within a frequency range between **30 MHz** and **1000 MHz**, the **EMC** option offers an attenuation between **30 dB** and **70 dB** of the electromagnetic emissions.

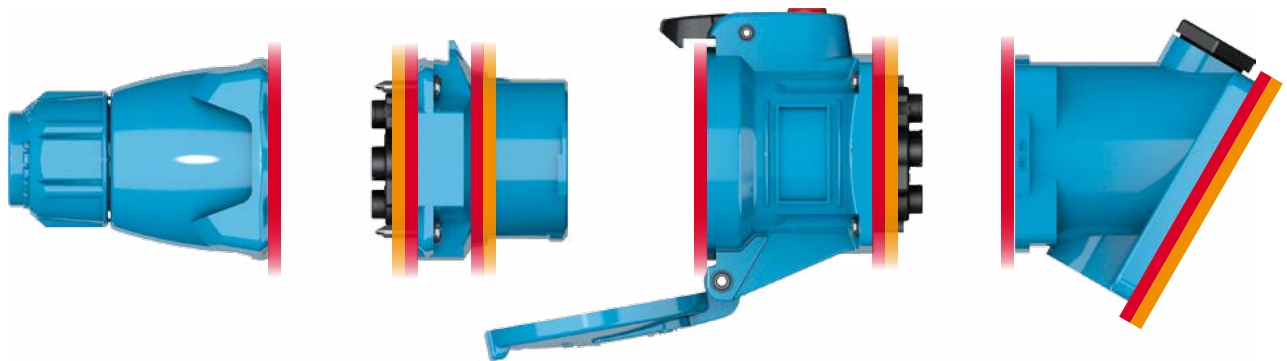

- All contact surfaces are un-protected to provide optimal electrical conductivity;
- Gaskets are fitted with metallic braided fabric, silicone with Monel threads or graphite-loaded, ensuring an excellent EMC performance.

MECHANICAL SELF-EJECTING SYSTEMS

Fixed electric power supply

Ejecting plug (inlet + handle)

Mobile power supply source

Ejecting coupler socket (handle + socket- outlet)





WEBSITE

- **Configure your product specification with our online configurator.**
- **Retrieve your business contacts.**
- **Download our documentation related to your field of activity.**
- **Download our products drawings.**
- **Learn more about our group.**
- **Discover our new products.**
- **Follow our current events.**

**FIND ALL INFORMATION
ON OUR WEBSITE:**



marechal.com



A team dedicated
to your needs

NON CONTRACTUAL DOCUMENT AND PICTURES

All the indications appearing in this catalogue are indicative and could not constitute a commitment on our part. We reserve the right to alter specifications of our products without any prior notice in our efforts to continuously improve our products features. For your information, the most updated version is the one of our website marechal.com.



WORLD PRESENCE

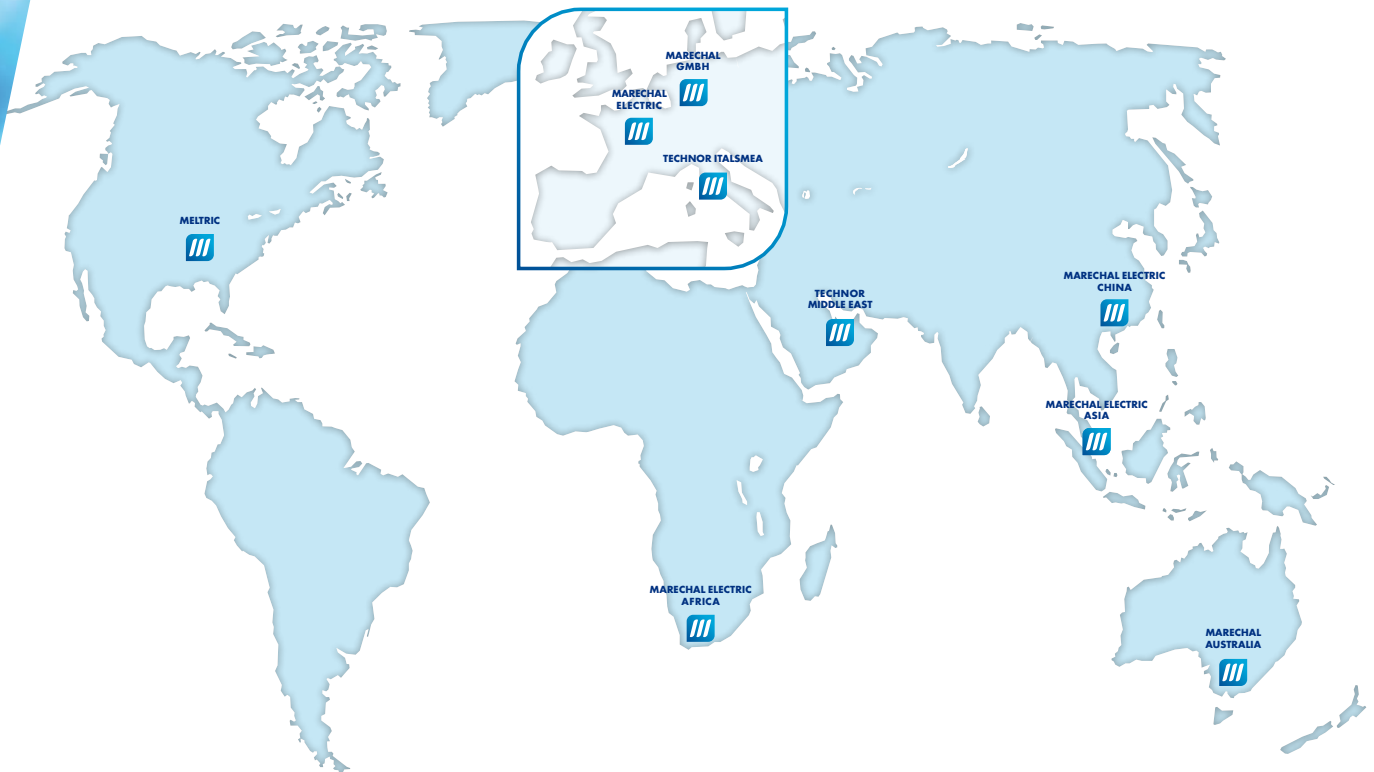

MARECHAL ELECTRIC S.A.S (Head Office)

5, avenue de Presles
94417 Saint-Maurice Cedex, FRANCE
Phone : +33 (0)1 45 11 60 00
Fax : +33 (0)1 45 11 60 60
e-mail: contact@marechal.com

Africa SADC area

MARECHAL ELECTRIC AFRICA (PTY) LTD.
PO Box 13875 Witfield 1467
Unit A1 Harvard Lane
Aero Star Business Park
Jet Park Road, Jet Park
South Africa
Tel.: +27 11 894 7226/7/8
Fax: 086 604 1778
e-mail: sales.za@marechal.com

Asia

MARECHAL ELECTRIC Asia Pte Ltd
#01-05 9@Tagore
9 Tagore Lane
Singapore 787472
Tel.: +65 6554 2722
Fax: +65 6455 9077
e-mail: sales.asia@marechal.com

Australia

MARECHAL AUSTRALIA PTY LTD
20 Technology Circuit
HALLAM VIC 3803
Australia
Tél. : +61 (0)38786 2500
Fax : +61 (0)38786 2511
e-mail : sales@marechal.com.au

China

MARECHAL ELECTRIC (CHINA) Co., Ltd
11 North Xiangshui Road,
West Dayawan District,
Huizhou.P.R.C
Tel/Fax: +86 (0)752-5319536
e-mail: sales.cn@marechal.com

Germany/Austria/Switzerland/ East Europe/Russia

MARECHAL GmbH
Im Lossenfeld 8
D-77731 Willstätt-Sand
Germany
Tel.: +49 (0)7852/91 96-0
Fax: +49 (0)7852/91 96-19
e-mail: info.de@marechal.com

Middle East

Technor Middle East DMCC
Unit No.2101, Fortune Executive
Tower, Plot No T1
Jumeirah Lakes Towers
P.O. Box 392054
Dubai, United Arab Emirates
Tel.: +971 4 362 1418
Fax: +971 4 362 1419
e-mail: sales.me@marechal.com

USA/Canada/Mexico

MELTRIC Corporation
4765 W. Oakwood Park Drive
Franklin WI 53132, USA
Tel.: +1 414 433 2700
Fax: +1 414 433 2701
e-mail: mail@meltric.com

TECHNOR

TECHNOR ITALSMEA S.p.A.
Via Italia 33,
20060 Gessate (MILANO)
Italia
Tél. : +39 02 95 00 151
Fax : +39 02 95 00 15 27
e-mail: sales@italsmea.com

For any other country or area, please contact head office.

marechal.com